

2020



# Product Highlights

---



# Monitoring and controlling for your safety

---

Tele Haase was founded in 1963 and is Austria's market leader in developing state-of-the-art monitoring, control and automation technology. We are known for operational excellence in the development and production of control and monitoring components for automation applications in industry and building automation.

**TELE PRODUCTS** are installed globally in various control cabinets or control installations. Thanks to the simple integration into new or existing systems, the reliable function and monitoring of electrical values has proven itself even in critical energy and facility management applications.

**TELE DEVELOPMENTS** meet international quality standards, contribute to the environmental

friendly generation of renewable energies using water, wind and sun and have long been what is known as green or clean.

**AT TELE HAASE**, we see ourselves as a "company of the future" with the aim of actively shaping social change towards sustainability in the long term. We develop technologies that help industries to become safer, more efficient and sustainable.

# All over the world

We are the Austrian market leader for timing and monitoring relays. Our relays might be small but they master a huge variety of applications.



## TELE at a glance

- ✓ Monitoring devices for physical values such as current, voltage, temperature, frequency, level, power factor, active power ...
- ✓ Provider of high-quality industrial switching relays and power electronics
- ✓ Grid and system protection for renewable energies
- ✓ Extensive technical expertise thanks to nearly 60 years of experience
- ✓ Global sales network
- ✓ Electronic manufacturing services at crisis-proof location in Vienna, Austria

## Made in Austria

Over 80 highly qualified employees meet the high demands and wishes of our customers every day. TELE Haase produces one hundred percent of its products in Austria. Our core areas of expertise are development and production – including EMS – at our head office in Vienna. The TELE sales team and more than 60 international trade partners make up our global sales network and stand by for your support.

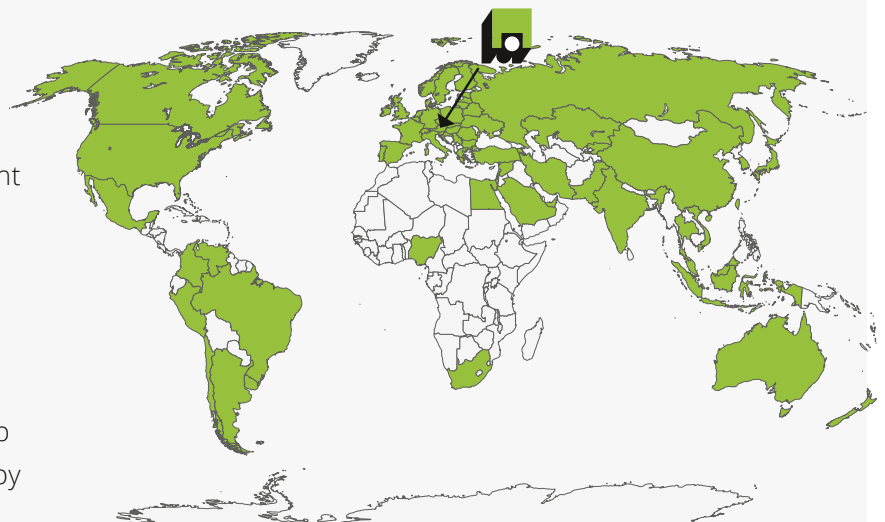

# Who **we** are

We have nearly 60 years of experience in the development and production of control and monitoring components and we are happy to share this know-how with our customers.

## At the Vienna location

we are committed to the highest quality, sustainability and outstanding customer service, both in the production of our own products and in EMS production. In the professional implementation of innovative ideas from customers we score with flexibility and reliability.



## How do you benefit from this?

- Short development and realization times
- Proven modular components
- Ability to integrate into the customer's system
- Scalable in price and performance
- In-house development and production with optimized batch sizes

# Our business areas

With solid engineering know-how, TELE develops and produces smart technology for a better world. We try out ideas and break new ground on our way to “the company of the future”.



## Automation components

According to our customers' needs, we develop and produce technical solutions for a wide variety of controlling and monitoring tasks, such as timing and monitoring relays, grid and system protection, power electronics and industrial IoT. TELE products are being used all over the world in control cabinets, plant and machinery, renewable energy sector or facility management.

## EMS

At TELE Haase you will find our conveniently located Electronic Manufacturing Services (EMS), which can flexibly adapt to your requirements with a personal touch and Austrian quality. We support you in ideation, electronic development, prototyping to serial production and delivery.



## Factory Hub Vienna

With the Factory Hub we offer space for new ideas and concepts of young founders and support startups with our extensive production know-how in the implementation of prototypes and small series.

## Organisation Playground

TELE implemented a new organization structure in 2012 and invites people to join our experiences. Based on the idea of “New Work” we operate without traditional hierarchies and make democratic decisions. This promotes individual responsibility and agility, and puts us in a position to offer operational excellence at all levels in the future.



# Product categories

Our product range consists of the following high quality products:



## Timing relays

[page 7]

can make system and machine operation even more efficient. They check the time for you. For example, they switch off wind turbines after a preset time or fertilize grapevines for a defined timespan. Your production is never thrown off its rhythm, which saves money.



## Monitoring relays

[page 22]

measure and monitor current, voltage, temperature, frequency, level, power factor and active power. A variety of different enclosures for control technology, industrial systems, machinery and building installations allow for flexible use of relays. The rugged design offers excellent usability and installability.



## Power monitors

[page 36]

measure variables such as the power factor of a motor or the true power of a pump or fan. These measurements provide indications and important information about the state and functioning of machinery and installations, which reduces maintenance costs, service works and downtime.



## Grid and system protection

[page 44]

devices monitor the feed-in of energy to the 230/400V grid. In case of a power failure or disruption by the energy supplier it is vital for small power plants to be disconnected within a few milliseconds to avoid any danger to people and equipment.



## Complementary products

[page 48]

- Coupling units and signal converter
- Switching relays and sockets
- Current transformers
- Softstarter, Thyristor control units and braking units
- Hour meters and timers
- Switching power supplies

# Product series

Our large and small quartet:  
ENYA, VEO, GAMMA and KAPPA – play it safe!



ENYA



VEO



GAMMA



KAPPA

	ENYA	VEO	GAMMA	KAPPA
<b>PRODUCT CATEGORY</b>	<b>TIMING &amp; MONITORING RELAYS, COUPLING UNITS</b>	<b>TIMING &amp; MONITORING RELAYS</b>	<b>TIMING &amp; MONITORING RELAYS, POWER MONITORS</b>	<b>TIMING &amp; MONITORING RELAYS</b>
Dimensions (W×H×D)	17.5 / 35×87×65 mm	22.5 / 45×67×76 mm	22.5 / 45×90×108 mm	38×51×80 mm
Design	installation design	compact industrial design	industrial design	installation design
Labelling area	-	freely positionable or fixed	fixed	-
Product standards	EN 61812-1 EN 60947	EN 61812-1 EN 60947	EN 61812-1 EN 50178 EN 60947	EN 61812-1 EN 50178
Energy consumption	0.8 – 1.3W	extra low: 0.35 – 0.6W	1 – 1.5W	0.8 – 2W
Electrical connection	screw terminal	push-in terminal or screw terminal	screw terminal	plug-in housing mounted on screw terminal socket
Overvoltage category / Rated impulse withstanding voltage	III / 4kV	III / 4/6kV (protective separation)	III / 4/6kV	III / 4kV
Application field	building	industrial automation	industrial automation	building
Base accuracy	≤ 5%	≤ 2.5%	≤ 3%	≤ 5%

FOR THE ENTIRE PRODUCT RANGE PLEASE VISIT



[www.tele-online.com](http://www.tele-online.com)

# Product features

Each of our products is characterized by special features:

## ENYA

- ✓ Installation design (45 mm standard front dimension)
- ✓ Timing and monitoring relays, single and multifunction
- ✓ Width 17.5 mm and 35 mm, 1 or 2 changeover contacts (CO)
- ✓ UL listed, CE conformity marking
- ✓ Temperature range -25 to +55 °C
- ✓ Recessed potentiometer buttons, analog indication by means of LED
- ✓ 12 to 240V AC/DC, powered by measuring circuit
- ✓ Compact industrial design

## VEO

- ✓ Timing and monitoring relays, single and multifunction
- ✓ Width 22.5 mm and 45 mm, 1 or 2 changeover contacts (CO)
- ✓ Low profile
- ✓ UL listed, CE conformity marking
- ✓ Temperature range -25 to +60 °C
- ✓ Recessed potentiometer buttons, analog indication by means of LED
- ✓ 12 to 240V AC/DC, powered by measuring circuit

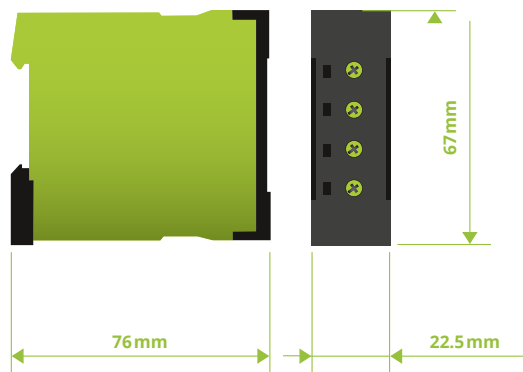
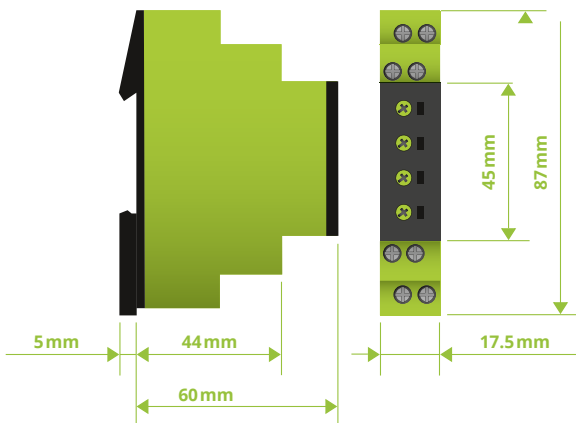



# GAMMA

- ✓ Industrial design
- ✓ Timing and monitoring relays, single and multifunction
- ✓ Width 22.5mm and 45mm, 1 or 2 changeover contacts (CO)
- ✓ UL listed, CE conformity marking
- ✓ Temperature range -25 to +55°C
- ✓ Recessed potentiometer buttons, analog indication by means of LED, digital indication by means of LCD-Display
- ✓ 12 to 240V AC/DC, powermodules 12 to 500V AC; 24V DC

# KAPPA

- ✓ Industrial design (45 mm standard front dimension)
- ✓ Timing and monitoring relays, single and multifunction
- ✓ Width 35mm, 2 changeover contacts (2CO) or 1 changeover and 1 normally open contact (1CO + 1NO)
- ✓ CE conformity marking
- ✓ Temperature range -25 to +55°C
- ✓ Recessed potentiometer buttons, analog indication by means of LED
- ✓ 12 to 240V AC/DC, powered by measuring circuit

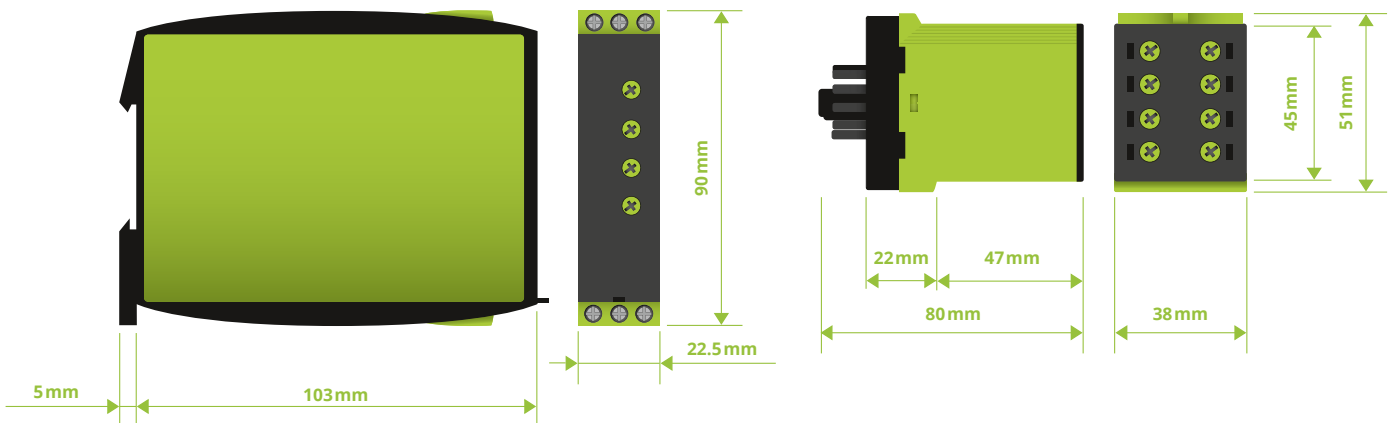

MORE PRODUCT INFOS



[www.tele-online.com](http://www.tele-online.com)

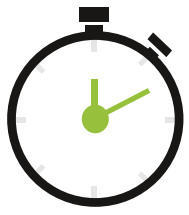

# Timing Relays

## Function Overview

Our timing relays have a variety of functions – here they are in detail:

<b>U</b>	Supply voltage	<b>LED U/t</b>	LED status indication for supply voltage and timing of function	<b>S</b>	Control/Trigger input
<b>LED</b>	LED status indication	<b>R</b>	Relay output	<b>Y</b>	Star/Wye time
<b>LED U</b>	LED status indication supply voltage	<b>T</b>	Thyristor output	<b>Δ</b>	Delta time
<b>LED R</b>	Led status indication relay output			<b>t</b>	Set time

### E ON DELAY

When the supply voltage U is applied, the set interval t begins. After the interval t has expired the output relay R switches into on-position. This status remains until the supply voltage is interrupted. If the supply voltage is interrupted before the expiry of the set interval, the interval t already expired is erased and is restarted when the supply voltage is next applied.

### A OFF DELAY WITHOUT AUXILIARY VOLTAGE

When the supply voltage U is supplied, the output relay R switches into on-position. If the supply voltage is interrupted, the set interval t begins. After the set interval t has expired the output relay R switches into off-position. If the supply voltage is reconnected before the interval t has expired the interval already is erased and is restarted with the next cycle.

### R OFF DELAY

The supply voltage U must be constantly applied to the device. When the control contact S is closed, the output relay R switches into on-position. If the control contact is opened, the set interval t begins. After the interval t has expired the output relay switches into off-position. If the control contact is closed again before the set interval has expired, the interval already expired is erased and is restarted.

### S STAR-DELTA START-UP

When the supply voltage U is applied, the star-contact switches into on-position and the set star-time t1 begins. After the interval t1 has expired the star-contact switches into off-position and the set transit-time t2 begins. After the interval t2 has expired the delta-contact switches into on-position. To restart the function the supply voltage must be interrupted and reapplied.

### ER ON DELAY AND OFF DELAY WITH CONTROL CONTACT

The supply voltage U must be constantly applied to the device. When the control contact S is closed, the set interval t1 begins. After the interval t1 has expired, the output relay R switches into on-position. If the control contact is opened, the set interval t2 begins. After the interval t2 has expired, the output relay switches into off-position. If the control contact is opened before the interval t1 has expired, the interval already expired is erased and is restarted with the next cycle.

### Ec ADDITIVE ON DELAY

When the supply voltage U is applied, the release for the interval starts. When the control contact S is closed, the set interval t begins. If the control contact S is opened during the set interval t, the interval stops, and the already expired interval is stored. During the lapse of time the control contact can be opened or closed as often as required. If the sum of the periods, in which the control contact S is closed reaches the set interval t the output relay R switches into on-position. The interval is stopped and a further activation of the control contact S remains without effect. By interrupting the supply voltage, the device will be reset. A possibly expired time t is deleted.

### Es ON DELAY WITH CONTROL INPUT

The supply voltage U must be constantly applied to the device. When the control contact S is closed, the set interval t begins. After the interval t has expired the output relay R switches into on-position. This status remains until the control contact is opened again. If the control contact is opened before the interval t has expired, the interval already expired is erased and is restarted with the next cycle.

### ET ON DELAY TWO WIRE CONNECTED

When the supply voltage U is applied, the set interval t begins. After the interval has expired the thyristor switches on. This status remains until the supply voltage is interrupted. If the supply voltage is interrupted before the expiry of the interval, the interval already expired is erased and is restarted when the supply voltage is next applied.

### Wu SINGLE SHOT LEADING EDGE VOLTAGE CONTROLLED

When the supply voltage U is applied, the output relay R switches into on-position and the set interval t begins. After the interval t has expired the output relay switches into off-position. This status remains until the supply voltage is interrupted. If the supply voltage is interrupted before the interval t has expired, the output relay switches into off-position. The interval already is erased and is restarted when the supply voltage is next applied.

### EWu ON DELAY SINGLE SHOT LEADING EDGE WITH CONTROL CONTACT

When the supply voltage U is applied, the set interval t1 begins. After the interval t1 has expired, the output relay R switches into on-position and the set interval t2 begins. After the interval t2 has expired, the output relay switches into off-position. If the supply voltage is interrupted before the interval t1+t2 has expired, the interval already expired is erased and is restarted when the supply voltage is next applied.

### nWu MAINTAINED SINGLE SHOT LEADING EDGE

When the supply voltage U is applied, the output relay R switches into on-position and the set interval t begins. After the interval t has expired the output relay switches into off-position. This status remains until the supply voltage is interrupted. If the supply voltage is reconnected before the interval t has expired, the unit continues to perform the actual single shot.

### Ws SINGLE SHOT LEADING EDGE WITH CONTROL INPUT

The supply voltage U must be constantly applied to the device. When the control contact S is closed, the output relay R switches into on-position and the set interval t begins. After the interval t has expired the output relay switches into off-position. During the interval, the control contact can be operated any number of times. A further cycle can only be started when the cycle run has been completed.

**EWs ON DELAY SINGLE SHOT LEADING EDGE WITH CONTROL CONTACT**

The supply voltage U must be constantly applied to the device. When the control contact S is closed, the set interval t1 begins. After the interval t1 has expired, the output relay R switches into on-position and the set interval t2 begins. After the interval t2 has expired, the output relay switches into off-position. During the interval, the control contact can be operated any number of times. A further cycle can only be started when the cycle run has been completed.

**Wa SINGLE SHOT TRAILING EDGE WITH CONTROL INPUT**

The supply voltage U must be constantly applied to the device. Closing the control contact S has no influence on the condition of the output R. When the control contact is opened, the output relay switches into on-position and the set interval t begins. After the set interval has expired, the output relay switches into off-position. During the interval, the control contact can be operated any number of times. A further cycle can only be started when the cycle run has been completed.

**nWa MAINTAINED SINGLE SHOT TRAILING EDGE**

When the supply voltage U is supplied, the output relay R remains into off-position. As soon as the supply voltage is interrupted the output relay switches into on-position and the set interval t begins. After the set interval t has expired the output relay switches into off-position. When the supply voltage is reconnected before the interval t has expired, the unit continues to perform the actual single shot.

**nWuWa MAINTAINED SINGLE SHOT LEADING AND TRAILING EDGE**

When the supply voltage U is applied, the output relay R switches into on-position and the set interval t begins. After the interval t has expired the output relay switches into off-position. As soon as the supply voltage is interrupted the output relay switches into on-position again and the set interval t begins. After the set interval t has expired the output relay switches into off-position. If the supply voltage is interrupted (nWu) or reconnected (nWa) before the interval t has expired the unit continues to perform the actual single shot

**WsWa SINGLE SHOT LEADING AND SINGLE SHOT TRAILING EDGE WITH CONTROL CONTACT**

The supply voltage U must be constantly applied to the device. When the control contact S is closed, the output relay R switches into on-position and the set interval t1 begins. After the interval t1 has expired, the output relay R switches into off-position. If the control contact is opened, the output relay again switches into on-position and the set interval t2 begins. After the interval t2 has expired the output relay switches into off-position. During the interval, the control contact can be operated any number of times.

**Bi FLASHER PULSE FIRST**

When the supply voltage U is applied, the output relay R switches into on-position and the set interval t begins. After the interval t has expired, the output relay R switches into off-position and the set interval t begins again. The output relay is triggered at a ratio of 1:1 until the supply voltage is interrupted.

**Bp FLASHER PAUSE FIRST**

When the supply voltage U is applied, the set interval t begins. After the interval t has expired, the output relay R switches into on-position and the set interval t begins again. After the interval t has expired, the output relay switches into off-position. The output relay is triggered at a ratio of 1:1 until the supply voltage is interrupted.

**Wt PULSE DETECTION**

When the supply voltage U is applied, the set interval t1 begins and the output relay R switches into on-position. After the interval t1 has expired, the set interval t2 begins. So that the output relay R remains in on-position, the control contact S must be closed and opened again within the set interval t2. If this does not happen, the output relay R switches into off-position and all further pulses at the control contact are ignored. To restart the function the supply voltage must be interrupted and reapplied.

### Wtf PULSE SEQUENCE MONITORING EDGE TRIGGERED



When the supply voltage U is applied the green LED U/t illuminated. When the control contact S is closed (rising edge) the output relay R switches into on- position (yellow LED illuminated) and the set interval t begins (green LED U/t flashes). So that the output relay R remains in on-position, the control contact S must be opened and closed again within the set interval t. If this does not happen, the output relay R switches into off-position. If a new positive edge on the control input is detected, the interval t begins (green LED U/t flashes) and the outputs relay R switches into on-position (yellow Led illuminated).

### Wto PULSE SEQUENCE MONITORING EDGE TRIGGERED WITH ON STATE



When the supply voltage U is applied the green LED U/t illuminated and if the control input S is on at the same time the set interval t begins (green LED U/t flashes) and the output relay R switches into on position (yellow Led illuminated). If there is no rising edge detected on the control input S, then the Relay R switches into off state. When the control contact S is closed (rising edge) again the output relay R switches into on- position (yellow Led illuminated) and the set interval t begins (green LED U/t flashes). So that the output relay R remains in on-position, the control contact S must be opened and closed again within the set interval t. If this does not happen, the output relay R switches into off-position. If a new positive edge on the control input is detected, the interval t begins (green LED U/t flashes) and the output relay R switches into on-position (yellow Led illuminated).

### Ii ASYMMETRIC FLASHER PULSE FIRST

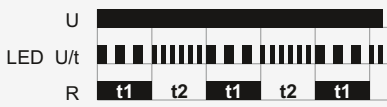

When the supply voltage U is applied, the output relay R switches into on-position and the set interval t1 begins. After the interval t1 has expired, the output relay switches into off-position and the set interval t2 begins. After the interval t2 has expired, the output relay switches into on-position. The output relay is triggered at the ratio of t1:t2 until the supply voltage is interrupted.

### Ip ASYMMETRIC FLASHER PAUSE FIRST

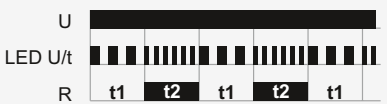

When the supply voltage U is applied, the set interval t1 begins. After the interval t1 has expired, the output relay R switches into on-position and the set interval t2 begins. After the interval t2 has expired, the output relay switches into off-position. The output relay is triggered at the ratio of t1:t2 until the supply voltage is interrupted.

### TW FUNCTION AUTOMATIC TIMER WITH (TW) OR WITHOUT (T) SWITCH-OFF WARNING

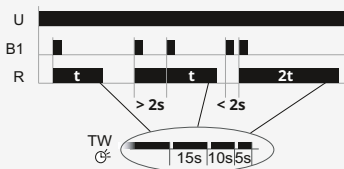

After the pushbutton (control input) has been pressed, the output relay R closes and the set interval t begins. If the pushbutton is pressed again before the interval has expired, the interval begins again (restart function complies with EN 60669-2-3). Rapid, multiple pressing of the pushbutton (pumping) adds 2, 3 or more time intervals to extend the time up to 60min. Prolonged pressure on the button (>2 s) aborts the interval running and switches the relay off (energy saving function). In the TW mode the device provides a switch-off warning (in accordance with DIN 180-158-2) by generating short pulses (flashing) at 30s, 15s and 5s prior to switch-off.

### P IMPULSE SWITCH MODE



In this mode, every keypress of the pushbutton (control input) toggles the output relay R (flip-flop). In function P, the output relay remains in off-position, whenever the supply voltage is applied. In function PN, the output relay switches into on-position after applying the supply voltage U, if the output relay was in on-position last before power failure. In both functions the output relay switches into on-position, if a short voltage impulse (<2s) is applied to the additional control input (central ON). A longer voltage impulse (>2s) opens the output relay (central OFF).

### P ( R ) IMPULSE SWITCH MODE WITH OFF DELAY

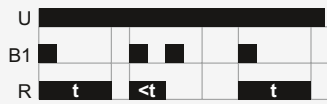

In this mode, every keypress toggles the output relay R (flip-flop). After the pushbutton (control input) has been pressed, the output relay closes and the set interval t begins. After the interval has expired the output relay switches into off-position. If the pushbutton is pressed again before the interval has expired, the interval will be canceled and the output relay switches into off-position.

### LA LOAD ALTERNATOR – PUMP CHANGER

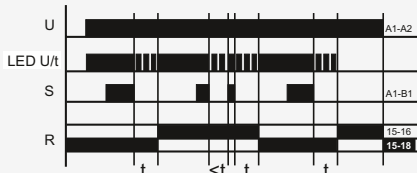

In this mode, every falling edge toggles the output relay R (flip-flop) from L1 to L2 or L2 to L1 whatever position is defined by the previous status. On Power-Up the relay R stays in off condition until the first falling edge is detected on S Terminal B1. To ensure a safe and optimal function, please turn both timing controllers on the front to the most left position (CCW), which equals 50msec. In this operation mode, a minimum delay/de-bump time of 50msec is applied from the falling edge of the control input until relay R is changing its state. Is a longer delay time as 50msec is set, a short pulse on the „S“ input resets the times. The timer is restarted with the next falling edge signal on „S“ input again. If you wish to apply longer delay times, set the according time selectors to the required values or contact your application engineer.



# E1ZMLA10

Our 3in1 pump alternating relay offers the highest performance in the industry's most compact and space-saving DIN-Rail enclosure style.

**TELE'S DUPLEXER CONTROLS TWO** loads simultaneously and upgrades the regular alternating function by an integrated ON and OFF delay feature. The selector switch allows the user to lock in one sequence while the relay works with a wide range control voltage of 24 – 240V AC/DC.

**OUR E1ZMLA** is often used in special applications where optimization of load usage is required by balancing the runtime of two loads. Identical loads are used for the same task – one or more standby units are available in case the first load fails. However, an idle load might deteriorate due to lack of use and thereby

lose its safety margin. Alternating relays prevent this by assuring that multiple loads get equal run time. In addition, there are situations where a need arises to have multiple loads on at the same time for additional capacity if one load cannot keep up with demand.

This alternating functionality "LA" is initiated by a control switch, such as a float switch, manual switch, timing relay, pressure switch or other isolated contact. Each time the initiating switch is opened, the output relay contacts will change state, thus alternating the two loads. Two LED indicators show the status of the output relay, control voltage and timing function.

## Advantages

- 3in1 Duplex control of two loads
- Integrated OFF and ON delay
- Load alternator w/ selector switch to lock loads manually
- Control voltage 24 – 240V AC/DC
- 8A@250VAC SPDT output
- Low profile selector switch
- 2 LEDs for relay status, timing and operating voltage indication
- cULus, CE, EAC, RoHS
- Rugged design for industrial applications
- Improved inventory maintenance

TYPE DESIGNATION	FUNCTIONALITY	DIMENSIONS (W × H × D)	ART.NO.
E1ZMLA10 24-240V AC/DC	load alternator (LA), ON (E) and OFF (R) delay	17.5×87×65mm	110218



MODEL	E1ZM10	E1ZMQ10	E1ZMWT10	E1ZMW10	E1ZMLA10
-------	--------	---------	----------	---------	----------

**ORDER INFORMATION**

PART NO single package	110100 (12 – 240V) 110200 (24 – 240V)	110202	110217	-	110218
PART NO packaging unit (10 pcs)	110100A (12 – 240V) 110200A (24 – 240V)	110202A	-	110206A	-

**FUNCTIONALITY**

	multifunction	multifunction	multifunction	multifunction	multifunction
<b>E</b> ON delay	■	■	■	■	■
<b>R</b> OFF delay	■	■	■	■	■
<b>Es</b> ON delay with control contact	■	■			
<b>Wu</b> Single shot leading edge, voltage-controlled	■	■		■	
<b>Ws</b> Single shot leading edge with control contact	■		■	■	
<b>Wa</b> Single shot trailing edge with control contact	■		■	■	
<b>Bp</b> Flasher pause first	■				
<b>Wt</b> Pulse repetition analysis			■	■	
<b>Wtf</b> Pulse sequence monitoring edge triggered			■		
<b>Wto</b> Pulse sequence monitoring edge triggered with on state			■		
<b>WsWa</b> Single shot leading and trailing edge with control contact				■	
<b>La</b> Load alternator – pump changer					■

**POWER SUPPLY CIRCUIT**

Supply voltage	12 – 240V AC/DC 24 – 240V AC/DC	24 – 240V AC/DC	24 – 240V AC/DC	24 – 240V AC/DC	24 – 240V AC/DC
Setting range	48 – 63 Hz				

**TIME CIRCUITS**

Time ranges	7				
Setting range	0.05s – 100 h				

**INPUT CIRCUIT**

Control signal	■	■	■	■	■
----------------	---	---	---	---	---

**OUTPUT CIRCUIT**

Number of switching contacts	1 CO contact	1 CO contact	1 CO contact	1 CO contact	1 CO contact
Max. switching capacity	2000VA (8A / 250V AC)				

**DESIGN**

Dimensions (W×H×D)	17.5×87×65 mm 35×87×65 mm				
Certificates	CE, cULus, EAC	CE, cULus, EAC	CE, EAC	CE, cULus, EAC	CE, cULus, EAC



MODEL	E3ZI20	E1ZI10	E1ZTP	E1ZNT	E1ZWI
<b>ORDER INFORMATION</b>					
PART NO single package	111101	110101	110301	110500	110310
<b>FUNCTIONALITY</b>	emergency light tester	ON delay	asymmetric flasher	asymmetric flasher	star-delta
<b>ER</b> ON delay and OFF delay with control contact	■				
<b>EWu</b> ON delay single shot leading edge, voltage-controlled	■				
<b>Ws</b> Single shot leading edge with testkey				■	
<b>EWs</b> ON delay single shot leading edge with control contact	■				
<b>Ip</b> Asymmetric flasher pause first		■			
<b>Ii</b> Asymmetric flasher pulse first		■			
<b>Wt</b> Pulse repetition analysis	■				
<b>WsWa</b> Single shot leading and trailing edge with control contact	■				
<b>FUNCTIONALITY STAIRCASE LIGHTING TIMER</b>					
<b>T</b> Automatic timer without switch-off warning			■		
<b>TW</b> Automatic timer with switch-off warning			■		
<b>1</b> Steady light (ON)			■		
<b>0</b> Switch-off			■		
<b>P</b> Impulse switch mode without time function (only types with option P)			■		
<b>PN</b> Impulse switch mode power fail latch (only types with option PN)					■
<b>POWER SUPPLY CIRCUIT</b>					
Supply voltage	12 – 240V AC/DC	12 – 240V AC/DC	230V AC	230V AC	230V AC
Frequency range	48 – 63Hz				
<b>TIME CIRCUITS</b>					
Time ranges	7	7	1	1	1
Setting range	1 s – 100 h	1 s – 100 h	0,5 – 12 min	10 min – 3 h	6 – 60 min
<b>INPUT CIRCUIT</b>					
Control signal	■	■	■	integrated test key	■
<b>OUTPUT CIRCUIT</b>					
Number of switching contacts	2 CO contact	1 CO contact	1 CO contact	1 CO contact	1 CO contact
Max. switching capacity	2000VA (8A / 250V AC)	2000VA (8A / 250V AC)	4000VA (16A / 250V AC)	4000VA (16A / 250V AC)	4000VA (16A / 250V AC)
<b>DESIGN</b>					
Dimensions (W×H×D)	35×87×65 mm		17,5×87×65 mm		
Certificates	CE, cULus, EAC	CE, cULus, EAC	CE, EAC	CE, EAC	CE, EAC





MODEL	V2ZM10	V2ZQ10	V2ZI10	V2ZS20	V2ZA10 3MIN	V2ZET
-------	--------	--------	--------	--------	-------------	-------

**ORDER INFORMATION**

PART NO Screw terminal	125100	125150	125200	125300	125500	125130 (12-240V AC/DC) 125132 (50ms 230V AC) 125133 (50ms 110V AC)
PART NO Push-in terminal	125600	125650	125210	125310	125510	-
PART NO packaging unit (10 pcs)	125100A	125150A	-	-	-	-

**FUNCTIONALITY**

	multifunction	2-time multifunction	star-delta	multifunction	ON delay 2 wire
<b>E</b> ON delay	■	■		■	
<b>ET</b> ON delay 2 wire connected					■
<b>A</b> OFF delay without auxiliary voltage				■	
<b>R</b> OFF delay	■	■			
<b>Ec</b> Additive ON delay	■				
<b>Es</b> ON delay with control input	■				
<b>Wu</b> Single shot leading edge voltage controlled	■	■			
<b>nWu</b> Maintained single shot leading edge				■	
<b>Ws</b> Single shot leading edge with control input	■				
<b>Wa</b> Single shot trailing edge with control input	■				
<b>nWa</b> Maintained single shot trailing edge				■	
<b>nWuWa</b> Maintained single shot leading and trailing edge				■	
<b>Bi</b> Flasher pulse first	■				
<b>Bp</b> Flasher pause first	■	■			
<b>Wt</b> Pulse sequence monitoring	■				
<b>Ip</b> Asymmetric flasher pause first			■		
<b>Ii</b> Asymmetric flasher pulse first			■		
<b>S</b> Star-delta start-up			■		

**SUPPLY CIRCUIT**

Supply voltage	12 – 240V AC/DC	24 – 240V AC/DC	12 – 240V AC/DC	12 – 240V AC/DC	24 – 240V AC/DC	12 – 240V AC/DC (125130) 230V AC (125132) 110V AC (125133)
Frequency range	48 – 63Hz or DC					

**TIME CIRCUITS**

Time ranges	10	10	4	4	5 (125130) 1 (125132, 125133)
Setting range	0,05s – 100 h	0,05s – 100 h	0,05s – 3min	0,1s – 3min	0,05s – 1 h (125130) 50ms (125132, 125133)

**INPUT CIRCUIT**

Control signal	■	■	-	-	-
----------------	---	---	---	---	---

**OUTPUT CIRCUIT**

Number of switching contacts	1 CO contact	1 CO contact	2 NO contact	1 CO contact	1 thyristor
Max. switching capacity	2000VA (8A / 250V AC)	2000VA (8A / 250V AC)	750VA (3A / 250V AC)	2000VA (8A / 250V AC)	125VA / 250V AC

**DESIGN**

Dimensions (W×H×D)	22,5×67×76 mm					
Certificates	CE, cULus, EAC (devices with push-in terminal are not cULus listed)					



MODEL	G2ZM20	G2ZMF11	G2ZI20	G2ZIF20	G2ZA20
<b>ORDER INFORMATION</b>					
PART NO Screw terminal	-	120100	-	120200	120601
PART NO Push-in terminal	120401	120103	120501	120201	120600
<b>FUNCTIONALITY</b>					
	multifunction	multifunction	multifunction	multifunction	multifunction
E ON delay	■	■			■
A OFF delay without auxiliary voltage					■
R OFF delay	■	■			
ER ON delay and OFF delay with control contact			■	■	
Es ON delay with control input	■	■			
Wu Single shot leading edge voltage controlled	■	■			
EWu ON delay single shot leading edge with control contact			■	■	
nWu Maintained single shot leading edge					■
Ws Single shot leading edge with control input	■	■			
EWs ON delay single shot leading edge with control contact			■	■	
Wa Single shot trailing edge with control input	■	■			
nWa Maintained single shot trailing edge					■
nWuWa Maintained single shot leading and trailing edge					■
Wswa Single shot leading and single shot trailing edge with control contact			■	■	
Bi Flasher pulse first	■	■			
Bp Flasher pause first	■	■			
Ip Asymmetric flasher pause first			■	■	
Ii Asymmetric flasher pulse first			■	■	
<b>POWER SUPPLY CIRCUIT</b>					
Supply voltage	12 – 240V AC/DC	24 – 240V or freely selectable via power module TR2, SNT2	12 – 240V AC/DC	24 – 240V or freely selectable via power module TR2, SNT2	24 – 240V or freely selectable via power module TR2, SNT2
Frequency range	48 – 63Hz				
<b>TIME CIRCUITS</b>					
Time ranges	7	16	7	10	4
Setting range	0,05s – 100 h	0,05s – 30 d	0,05s – 100 h	0,05s – 10 h	1 s – 10 min
<b>INPUT CIRCUIT</b>					
Control signal	■	■	■	■	-
Remote potentiometer	-	■	-	■	-
<b>OUTPUT CIRCUIT</b>					
Number of switching contacts	2 CO contact	1 delayed / 1 instantaneous CO contact	2 CO contact	2 CO contact	2 CO contact
Max. switching capacity	1250VA (5A / 250V AC)				
<b>DESIGN</b>					
Dimensions (W×H×D)	22.5×67×76 mm				
Certificates	CE, cULus, EAC (devices with push-in terminal are not cULus listed)				



MODEL	K3ZM20	K3ZM20P	K3ZA20 3MIN	K3ZI20	K3ZS20
<b>ORDER INFORMATION</b>					
PART NO	135100	135200	135400	135101	135300
<b>FUNCTIONALITY</b>	multifunction	multifunction	2-times multifunction	2-times multifunction	star-delta
E ON delay	■	■	■		
A OFF delay without auxiliary voltage			■		
R OFF delay	■	■			
ER ON delay and OFF delay with control contact				■	
Es ON delay with control input	■	■			
Wu Single shot leading edge voltage controlled	■	■			
EWu ON delay single shot leading edge with control contact				■	
nWu Maintained single shot leading edge			■		
Ws Single shot leading edge with control input	■	■			
EWs ON delay single shot leading edge with control contact				■	
Wa Single shot trailing edge with control input	■	■			
nWa Maintained single shot trailing edge			■		
nWuWa Maintained single shot leading and trailing edge			■		
Wswa Single shot leading and single shot trailing edge with control contact				■	
Bp Flasher pause first	■	■			
Ip Asymmetric flasher pause first				■	
Ii Asymmetric flasher pulse first				■	
Wt Pulse sequence monitoring				■	
S Star-delta start-up					■
<b>SUPPLY CIRCUIT</b>					
Supply voltage	12 – 240V AC/DC	12 – 240V AC/DC	24 – 240V AC/DC	12 – 240V AC/DC	12 – 240V AC/DC
Frequency range	48 – 63Hz				
<b>TIME CIRCUITS</b>					
Time ranges	7	7	4	7	4
Setting range	0,05s – 100 h	0,05s – 100 h	0,1s – 3 min	0,05s – 100 h	0,05s – 3 min
<b>INPUT CIRCUIT</b>					
Control signal	■	■ (isolated)	-	■	-
<b>OUTPUT CIRCUIT</b>					
Number of switching contacts	2 CO contacts				
Max. switching capacity	2000VA (8A / 250V AC)				
<b>DESIGN</b>					
Dimensions (W×H×D)	38×51×80 mm				
Certificates	CE, EAC				

**KAPPA SERIES** TIMING RELAYS / **SOCKETS** (PF-113BE) R11X AND PF-113BE/M (ES12)

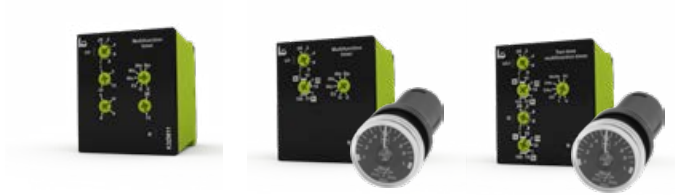

MODEL	K3ZM11	K3ZMF20	K3ZIF20	PF-113BE (R11X)	PF-113BE/M (ES12)
<b>ORDER INFORMATION</b>				<b>ACCESSORIES FOR KAPPA RELAYS</b>	
PART NO	135500	135600	135700	180155	180136
<b>FUNCTIONALITY</b>	multifunction	multifunction	2-times multifunction	sockets	
<b>E</b> ON delay	■	■		11-pole socket for mounting KAPPA relays on DIN-Rail TS 35	
<b>R</b> OFF delay	■	■			
<b>ER</b> ON delay and OFF delay with control contact			■		
<b>Es</b> ON delay with control contact	■	■			
<b>Wu</b> Single shot leading edge, voltage-controlled	■	■			
<b>EWu</b> ON delay single shot leading edge, voltage-controlled			■		
<b>Ws</b> Single shot leading edge with control input		■			
<b>EWs</b> ON delay single shot leading edge with control contact			■		
<b>Wa</b> Single shot trailing edge with control input	■	■			
<b>Wswa</b> Single shot leading and trailing edge with control contact			■		
<b>Bp</b> Flasher pause first	■	■			
<b>lp</b> Asymmetric flasher pause first			■		
<b>li</b> Asymmetric flasher pulse first			■		
<b>Wt</b> Pulse sequence monitoring			■		
<b>SUPPLY CIRCUIT</b>					
Supply voltage DC	24V			depends on selected KAPPA relays	
Supply voltage AV	24V, 110 – 240V			depends on selected KAPPA relays	
Frequency range	48 – 63Hz			depends on selected KAPPA relays	
<b>TIME CIRCUITS</b>				<b>PACKAGING UNIT</b>	
Time ranges	16	7	7	1 or 10 pcs	10 pcs
Setting range	0,05s – 30d	0,05s – 100h	0,05s – 100h		
<b>INPUT CIRCUIT</b>					
Control signal	■	■	■		
Remote potentiometer		■	■		
<b>OUTPUT CIRCUIT</b>					
Number of switching contacts	2 CO contacts	1 CO + 1 NO contact	1 NC + 1 NO contact	depends on selected KAPPA relays	
Max. switching capacity	2000VA (8A / 250V AC)	2000VA (8A / 250V AC)	2000VA (8A / 250V AC)	depends on selected KAPPA relays	
<b>DESIGN</b>					
Dimensions (W×H×D)	38×51×80 mm			38×61,5×26 mm	38×75×26 mm
Certificates	CE, EAC			CE, cULus, CSA	CE, cULus, CSA

Remote potentiometer can be found on page 47.

# Timing relays for various applications



## Safe switch-off

**E1ZM10 24-240** To prevent fire hazard, the stove in a dormitory shared kitchen must switch off safely after a defined period of time. The switch needs to perform even if the central pushbutton has been illegally blocked.

## Fluid level monitoring

**V2ZQ10** In pools of a wastewater treatment plant the use of the timing relay with Function E (switch-on delay) delays reading of the switch contact until the next usable measurement, and thereby prevents "flutter switching".



## Monitoring of a cold store door

**G2ZMF11** As soon as the control contact (Y1-Y2) is interrupted by opening the cold store door the cooling is switched off directly and the set time  $t$  starts to run. If the cold store door remains open for longer than the selected time, the delayed contact deactivates and an acoustic signal is triggered. This prevents the door from remaining open for too long or being improperly closed.



please scan QR code to see more timing relay applications





# Monitoring Relays Function Overview

## O OVER

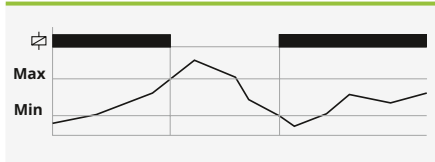

If the measured value exceeds the adjusted MAX threshold, the output relay switches into off-position. The output relay switches into on-position again, as soon as the measured value falls below the adjusted MIN threshold.

## U UNDER

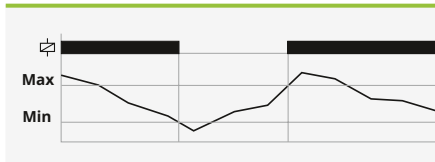

If the measured value falls below the adjusted MIN threshold, the output relay switches into off-position. The output relay switches into on-position again, as soon as the measured value exceeds the adjusted MAX threshold.

## W WINDOW

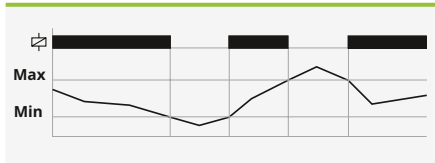

If the measured value falls below the adjusted MIN threshold, the output relay switches into off-position. The output relay switches into on-position again, as soon as the measured value exceeds the adjusted MAX threshold. If the measured value exceeds the adjusted MAX threshold, the output relay switches into off-position. The output relay switches into on-position again, as soon as the measured value falls below the adjusted MAX threshold.

## 2MIN MINIMUM MONITORING

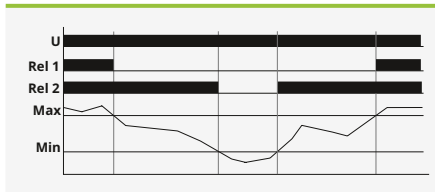

If the measured value falls below the adjusted MAX threshold, the output relay Rel1 switches into off-position. If the measured value falls below the adjusted MIN threshold, the output relay Rel2 switches into off-position. The output relays Rel1 and Rel2 switch into on-position again, as soon as the measured value exceeds the according adjusted threshold (MAX or MIN).

## 2MAX MAXIMUM MONITORING

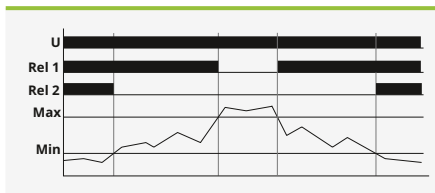

If the measured value exceeds the adjusted MIN threshold, the output relay Rel2 switches into off-position. If the measured value exceeds the adjusted MAX threshold, the output relay Rel1 switches into off-position. The output relays Rel1 and Rel2 switch into on-position again, as soon as the measured value falls below the according adjusted threshold (MAX or MIN).

## MM MINIMUM AND MAXIMUM MONITORING (MIN/MAX)

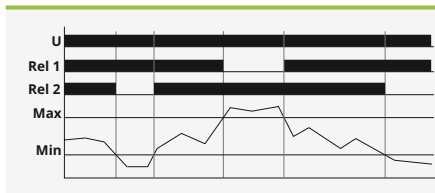

If the measured value falls below the adjusted MIN threshold, the output relay Rel2 switches into off-position. The output relay Rel2 switches into on-position again, as soon as the measured value exceeds the adjusted MIN threshold. If the measured value exceeds the adjusted MAX threshold, the output relay Rel1 switches into off-position. The output relay Rel1 switches into on-position again, as soon as the measured value exceeds the adjusted MIN threshold.

## TEMP TEMPERATURE MONITORING

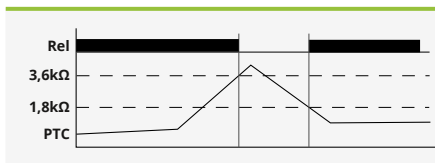

If the supply voltage U is applied and the cumulative resistance of the PTC-circuit is less than 3.6kΩ (standard temperature of the motor), the output relay R switches into on-position. When the cumulative resistance of the PTC-circuit exceeds 3.6kΩ, the output relay switches into off-position. The output relay switches into on-position again after the cumulative resistance falls below 1.6kΩ.

### PUMP UP



Connection of the probe rods E1, E2 and E3. When the air-fluid level falls below the minimum probe E2 the set interval of tripping delay begins. After the expiration of the interval, the output relay R switches into on-position. When the air-fluid level again rises above the maximum probe E1, the set interval of turn-off delay begins. After the expiration of the interval the output relay switches into off-position.

### PUMP DOWN

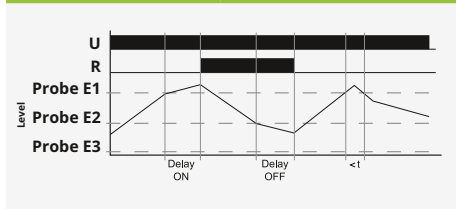

Connection of the probe rods E1, E2 and E3. When the maximum probe E1 gets moistened the set interval of tripping delay begins. After the expiration of the interval the output relay R switches into on-position. When the airfluid level falls below the minimum probe E2, the set interval of turn-off delay begins. After the expiration of the interval, the output relay switches into off-position.

### LATCH (ERROR MEMORY)



If the device detects a fault, the output relay only switches on again when the fault latch has been reset. The fault latch can be reset by means of an internal or external reset button or by interrupting the supply voltage.

### ASYM ASYMMETRY MONITORING

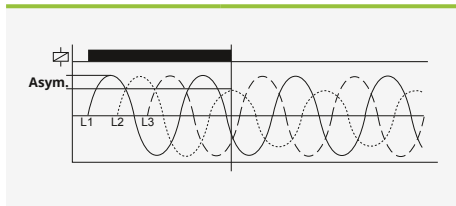

If the asymmetry of the phase-to-phase voltages exceeds the value set at the ASYM-regulator, the output relay switches into off-position. If the neutral wire is connected to the device, the asymmetry of the phase voltages referred to the neutral wire (Y-voltage) is monitored also. In that case both values of the asymmetry are evaluated and if one of the values exceeds the value set at the ASYM-regulator, the output relay switches into off-position.

### ON DELAY

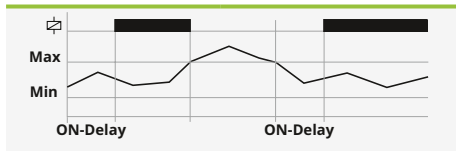

The output relay switches on if the monitored value is within the selected range during the defined time period.

### DELAY

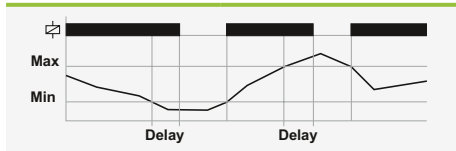

If the monitored value leaves the selected range, the output relay only switches into off-position following expiry of the trip delay.

### START START-UP SUPPRESSION

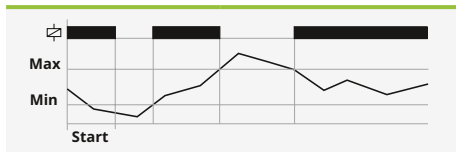

The output relay switches on when the supply voltage is applied. Changes to measured variables have no impact on the setting of the output relay during start up suppression.

### I = 0 RECOGNITION OF DISCONNECTED CONSUMERS

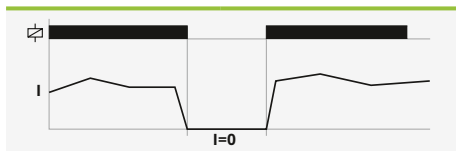

When the current flow between i and k is interrupted the output relay switches into off-position. When the current flow is restored, the measuring cycle is restarted with the set interval of the start-up suppression.



# VEO-V4LM4S30

TELE's new V4LM4S30 24-240V AC/DCV electrode relay for level monitoring in conductive fluids combines 10 different functions in one very compact device. It monitors the level of a fluid via probes, which are directly immersed.

Depending on the function selected, the V4LM controls the pumping in and pumping out as well as the running dry and overflow alarm. The device is utilized wherever observing a defined fill level represents an important criterion for the function, efficiency and safety. It protects machines and systems from leakage damage, fluid loss as well as running dry or overflow.

## FUNCTION

Unlike float switches, the TELE V4LM has no moving parts and thus has a long durability. In contrast to ultrasonic and radar measurements, the device is

resistant to contamination, dust, foam and mist in the containers. With extremely low probe voltage, small measuring currents and a large sensitivity window from 0.25 to 500 kOhm, the fill level measurement is suitable for feed applications and does not endanger animals. The selected measuring frequency of 18.3Hz enables an extremely robust measurement without interference (no harmonics to mains frequency 50 or 60Hz). In addition, the alternating current measurement prevents the build-up of oxyhydrogen gas as well as electrolytic disintegration of the probes, which can occur with comparable devices with direct current measurement.

## Advantages

- No moving parts (compared to a float switch)
- Robust against soil, dust, foam, mist in the containers (contrary to ultrasound and radar measurements)
- Extremely low probe voltage and measuring currents, therefore also suitable for animal feeding application
- Large sensitivity window (0.25 to 500kOhm)
- Robust measurement without interference by selecting the measuring frequency of 18.3Hz (no harmonic to mains frequency 50 or 60Hz), AC measurement also avoids oxyhydrogen gas formation and electrolytic decomposition of the probe.



**FUNCTION 1**

**PUMP UP WITH MIN-/MAX- ALARM**

(2uA) 1 container, 4 probes, 1 pump

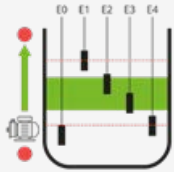

Level control between probes E2 and E3 by pumping up. The probes E1 and E4 serve as overflow – respectively as dry running alarm and may be used to control alarm devices, valves or additional pumps.

**FUNCTION 2**

**PUMP DOWN WITH MIN-/MAX- ALARM**

(2dA) 1 container, 4 probes, 1 pump

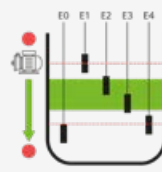

Level control between probes E2 and E3 by pumping down. The probes E1 and E4 serve as overflow – respectively as dry running alarm and may be used to control alarm devices, valves or additional pumps.

**FUNCTION 3**

**PUMP UP AND DOWN (bidirectional) WITH MINIMUM ALARM (3b-)**

1 container, 4 probes, 2 pumps

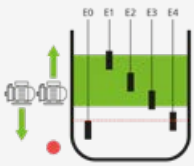

The level is controlled by pumping in and out around the level of probe E3. One example of the minimum alarm via probe E4 is used in dry-running warnings.

**FUNCTION 4**

**PUMP UP AND DOWN (bidirectional) WITH MAXIMUM ALARM (3b+)**

1 container, 4 probes, 2 pumps

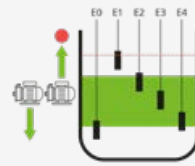

The level is maintained by pumping in and out around the level of probe E2. A maximum alarm via probe E1 warns of liquid overflow. Functions 3 and 4 can be changed during full operation.

**FUNCTION 5**

**TWO INDEPENDENT CONTAINERS – PUMP UP (2u2)**

1-2 container, 1-2 probes each, 1 pump each

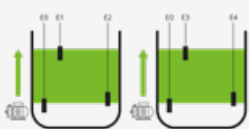

Pump up between probes E1-E2 respectively E3-E4 (alternatively control by one probe at a time). This feature allows level control in two separate containers with only one device. It is also possible to control cascades.

**FUNCTION 6**

**TWO INDEPENDENT CONTAINERS – PUMP DOWN (2d2)**

1-2 container, 1-2 probes each, 1 pump each

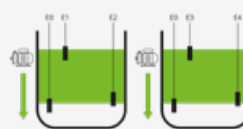

Pump down between probes E1-E2 respectively E3-E4 (alternatively control by one probe at a time). This feature allows level control in two separate containers with only one device. It is also possible to control cascades.

**FUNCTION 7**

**PUMP UP WITH INTEGRATED PUMP CHANGE**

(2uc) 1 container, 2 probes, 2 pumps

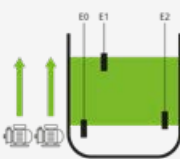

Pump up between control probes E1 and E2. The V4LM acts as an intelligent pump changer (for even use) with pump monitoring (feedback inputs E3 & E4). If a pump fails, the remaining pump is permanently prioritized and an alarm is issued, for maximum availability and uninterrupted operation through full redundancy.

**FUNCTION 8**

**PUMP DOWN WITH INTEGRATED PUMP CHANGE**

(2dc) 1 container, 2 probes, 2 pumps

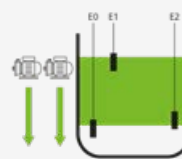

Pump down between control probes E1 and E2. The V4LM acts as an intelligent pump changer (for even use) with pump monitoring (feedback inputs E3 & E4). If a pump fails, the remaining pump is permanently prioritized and an alarm is issued, for maximum availability and uninterrupted operation through full redundancy.

**FUNCTION 9**

**WELL CONTROL (3w-) WITH WELL AND DRY ALARM**

1 well, 1 high tank, 3 probes, 1 pump

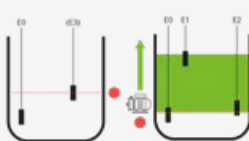

The function serves to ensure the water supply by means of a high tank and a well (pump up into the high tank from the well). Alarm functions: well alarm and dry alarm (high tank and well without water). The pump is protected against dry running in case liquid levels of a well (or feeding container) fall below a minimum value.

**FUNCTION 10**

**CODE OUTPUT FOR PLC CONNECTION**

(4ce) 1 container, 4 probes

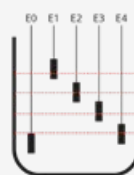

The 3 output relays are used to output the probe states by means of coding. Up to 4 level levels can be evaluated for one container. By connecting to an external controller, individual application conditions can be taken into account. Simple connection without external control unit can also protect up to four containers, with one probe each against overflow or dry running, and trigger a collective alarm.



# Operate pumps **fail-safe**



TELE pump alternators save life cycle costs and prevent production downtime.

Pump systems cause around a quarter of the world's electricity consumption. For this reason, consequent analysis of operating data and long-term optimization of the pump design offer enormous energy-saving potential. In addition, malfunctions that are not recognized in time cause around 70 percent of a pump's life cycle costs, often leading to production downtimes and resulting in high costs.

## PUMP MONITORING

This risk can be eliminated by appropriate monitoring, by measuring performance drops at an early stage and triggering an alarm or control measures. TELE has a whole series of devices, such as E1ZMLA, G2ASMA20 or V4LMS30 for this application. The devices recognize all unfavorable operating conditions of a pump, such

### Advantages

- Improve system reliability
- Increase pump efficiency
- Optimize maintenance cycles
- Prevent failure and reduction of downtimes
- Optimized utilization in parallel operation

as wear, but also blockage, wrong running, filter contamination, hot running, cavitation, temperature and dry running. In addition, some devices feature an integrated temperature monitor, which detects increased motor temperature, for example due to phase failure, frequent start-ups or blockages. Error states are reported immediately and thanks to timely maintenance, consequential damage to the system and thus expensive production downtimes can be avoided.

## PUMP CONTROL FOR PARALLEL OPERATION

For direct pump control, soft starters for pump start/stop as well as pump changers for alternately controlling pumps are used. In conveyor systems, pumps are usually designed to be redundant in order to maintain the system function in the event of machine damage and to cover short-term delivery peaks through parallel operation. Here the TELE pump alternator G2ASMA20 guarantees the alternating operation of both pumps, so that the reserve pump remains functional and does not fail in case of need.



MODEL	E1IM10 AACL10 230 V AC	E3IM10 AL20 230 V AC	E3IF500MAAC20	E3YF400 VE20 0.85	E3YF400 VT02 0.85
<b>ORDER INFORMATION</b>					
PART NO single package	1340200	1341200	1341201	1341404	1341402
<b>FUNCTIONALITY</b>					
1-phase ac current monitoring					
1-phase AC/DC current monitoring					
1-phase AC current monitoring					
3-phase AC voltage monitoring					
3-phase AC voltage monitoring					
<b>O ... Over</b>	■	■			
<b>U ... Under</b>	■	■	■	■	■
<b>W ... Window</b>	■	■			
<b>Test function</b>					■
<b>SWITCHING THRESHOLD</b>					
Maximum	10 – 100% of $I_N$	10 – 100% of $I_N$	-	-	-
Minimum	5 – 95% of $I_N$	5 – 95% of $I_N$	50 – 500mA	fixed, 195.5V (0.85)	fixed, 195.5V (0.85)
Asymmetry	-	-	-	-	-
<b>MEASURING CIRCUIT</b>					
Measuring variable	current AC sinus	current AC/DC AC sinus	current AC sinus	3(N)~ AC sinus	3(N)~ AC sinus
Measuring input	10A AC	100mA / 1A / 10A AC/DC	500mA AC*	$U_N = 400/230V AC$	$U_N = 400/230V AC$
<b>SUPPLY CIRCUIT</b>					
Supply voltage	230V AC -15% to +15%	230V AC	230V AC	= measuring voltage 3(N)~ 400/230V AC -30% to +30%	= measuring voltage 3(N)~ 400/230V AC -30% to +30%
Frequency range	48 – 63Hz				
<b>TIME CIRCUITS</b>					
Start-up surpression time (START)	-	0 – 10s	0 – 20min	-	-
Tripping delay (DELAY)	0,1 – 10s	0,1 – 10s	0 – 20min	-	fixed, approx. 200ms
ON delay	-	-	-	fixed, 1 min	-
<b>OUTPUT CIRCUIT</b>					
Number of switching contacts	1 CO contact	2 CO contact	2 CO contact	2 CO contact	2 CO contact
Max. switching capacity	1250VA (5A / 250V AC)	1250VA (5A / 250V AC)	1250VA (5A / 250V AC)	1250VA (5A / 250V AC)	1250VA (5A / 250V AC)
<b>DESIGN</b>					
Dimensions (W×H×D)	35×87×65 mm				
Certificates	CE, cULus, EAC	CE, EAC	CE, EAC	CE, cULus, EAC	

\* For currents greater than 5A, matching current transformers are available as accessories and can be found on page 49.

**ENYA SERIES** MONITORING RELAYS



MODEL	E1PF400 VSY01	E1PF400 VS01	E1PF480Y/277 VSY01	E1YF400 V01	E3YF400 V02
-------	---------------	--------------	--------------------	-------------	-------------

**ORDER INFORMATION**

PART NO single package	1340300	-	1340306	1340402 (0.85) 1340410 (0.70)	1341401
PART NO packaging unit (10 pcs)	1340300A	1340301A	-	1340402A (0.85)	-

**FUNCTIONALITY**

3-phase AC voltage monitoring

U ... Under				■	■
W ... Window					
SEQ ... Phase sequence	■	■	■		
Phase failure	■	■	■		
ASYM ... Asymmetry	■		■		

**SWITCHING THRESHOLD**

Minimum	-	-	-	fixed, 195.5V (0.85) fixed, 161V (0.70)	fixed, 195.5V
Asymmetry	5 – 25%, OFF	5 – 25%, OFF	5 – 25%, OFF	-	-

**MEASURING CIRCUIT**

Measuring variable	3(N)~ AC sinus	3(N)~ AC sinus	3~ AC sinus	3(N)~ AC sinus	3(N)~ AC sinus
Measuring input	$U_N = 400/230V AC$	$U_N = 400/230V AC$	$U_N = 208/120V$ to 480/277V AC	$U_N = 400/230V AC$	$U_N = 400/230V AC$

**SUPPLY CIRCUIT**

Supply voltage	= measuring voltage 3(N)~ 400/230V AC -30% to +30%	= measuring voltage 3(N)~ 400/230V AC -30% to +30%	= measuring voltage 3~ 208/120V to 480/277V AC -10% to +10%	= measuring voltage 3(N)~ 400/230V AC -30% to +10%	= measuring voltage 3(N)~ 400/230V AC -30% to +30%
Frequency range	48 – 63Hz				

**TIME CIRCUITS**

Tripping delay (delay)	fixed, approx. 100ms	fixed, approx. 100ms	fixed, approx. 100ms	fixed, approx. 200ms	fixed, approx. 200ms
------------------------	----------------------	----------------------	----------------------	----------------------	----------------------

**OUTPUT CIRCUIT**

Number of switch contacts	1 CO contact	1 CO contact	1 CO contact	1 CO contact	2 CO contacts
Max. switching capacity	1250VA (5A / 250V AC)				

**DESIGN**

Dimensions (W×H×D)	17.5×87×65mm	17.5×87×65mm	17.5×87×65mm	17.5×87×65mm	35×87×65mm
Certificates	CE, EAC	CE, EAC	CE, cULus, EAC	CE, EAC	CE, cULus, EAC



MODEL	E1YM400 VS10	E1YM480/277 VS10	E3YM230 VS20	E1UM230 V01	E3LM10 230 VAC
<b>ORDER INFORMATION</b>					
PART NO single package	1340405	1340409	1341406	1340101	1341500
<b>FUNCTIONALITY</b>					
3- and 1-phase AC voltage monitoring					level monitoring of conductive liquids
<b>U ... Under</b>	■	■	■	■	
<b>W ... Window</b>	■	■	■	■	
<b>SEQ ... Phase sequence</b>	■	■	■		
<b>Phase failure</b>			■		
<b>Pump up</b>					■
<b>Pump down</b>					■
<b>SWITCHING THRESHOLD</b>					
Maximum	80 – 130% of $U_N$	75 – 110% of $U_N$	80 – 130% of $U_N$	80 – 120% of $U_N$	-
Minimum	70 – 120% of $U_N$	65 – 100% of $U_N$	70 – 120% of $U_N$	75 – 115% of $U_N$	-
Asymmetry	5 – 25%, OFF	-	-	-	-
<b>MEASURING CIRCUIT</b>					
Measuring variable	3(N)~ AC sinus	3~ AC sinus	3(N)~ AC sinus	voltage AC/DC AC sinus	liquid level via conductive probes
Measuring input	$U_N = 400/230V AC$	$U_N = 480/277V AC$	$U_N = 230/132V AC$	24V AC/DC; 230V AC	0.25 – 100k $\Omega$
<b>SUPPLY CIRCUIT</b>					
Supply voltage	= measuring voltage 3(N)~ 400/230V AC -30% to +30%	= measuring voltage 3~ 480/277V AC -35% to +10%	= measuring voltage 3(N)~ 400/230V AC -30% to +30%	= measuring voltage 24V AC/DC; 230V AC -25% to +20%	230V AC -15% to +10%
Frequency range	48 – 63Hz	48 – 63Hz	48 – 63Hz	48 – 63Hz or DC	48 – 63Hz
<b>TIME CIRCUITS</b>					
Tripping delay (delay)	0.1 – 10s	0.1 – 10s	0 – 30s	-	0.5 – 10s
OFF delay	-	-	-	-	0.5 – 10s
<b>OUTPUT CIRCUIT</b>					
Number of switch contacts	1 CO contact	1 CO contact	2 CO contacts	1 CO contact	1 CO contact
Max. switching capacity	1250VA (5A / 250V AC)				
<b>DESIGN</b>					
Dimensions (W x H x D)	17.5x87x65mm	17.5x87x65mm	35x87x65mm	17.5x87x65mm	35x87x65mm
Certificates	CE, EAC	CE, cULus, EAC	CE, EAC	CE, cULus, EAC	CE, cULus, EAC

## VEO SERIES MONITORING RELAYS



MODEL	V2PF480Y/277 VSY01	V2PM400Y/230 VS10	V2UM230 V10	V2UF230 V10	V4P-F480Y/277 VSYTK02
-------	--------------------	-------------------	-------------	-------------	-----------------------

### ORDER INFORMATION

PART NO screw terminal	2100000	2100500	2100300	2100600	2104200
PART NO push-in terminal	2100010	2100510	2100310	-	2104210
PART NO packaging unit (10 pcs)	2100000A	-	-	-	-

### FUNCTIONALITY

	3-phase AC voltage monitoring	3-phase AC voltage monitoring	1-phase AC/DC voltage monitoring	1-phase voltage drop detector	3-phase AC voltage monitoring
<b>U ... Under</b>		■	■	■	
<b>W ... Window</b>		■	■		
<b>SEQ ... Phase sequence</b>	■	■			■
<b>Phase failure</b>	■	■			■
<b>ASYM ... Asymmetry</b>	■				■
<b>Voltage interruptions (fast detection)</b>				■	
<b>Temperature monitoring (PTC)</b>					■

### SWITCHING THRESHOLD

Maximum	-	75 – 130% of $U_N$	80 – 115% of $U_N$	-	-
Minimum	-	70 – 125% of $U_N$	75 – 110% of $U_N$	165V AC	-
Asymmetry	5 – 25%, OFF	-	-	-	5 – 25%, OFF

### MEASURING CIRCUIT

Measuring variable	3~ AC sinus	3~ AC sinus	voltage AC/DC AC sinus	voltage AC	temperature, voltage 3~ AC sinus
Measuring input	$U_N = 208/120V$ to 480/277V AC	$U_N = 400/230V$ AC	24V AC/DC; 230V AC	$U_N = 180 - 230V$ AC	$U_N = 208/120V$ to 480/277V AC

### SUPPLY CIRCUIT

Supply voltage	= measuring voltage 3~ 208/120V to 480/277V AC -10% to +10%	= measuring voltage 3(N)~ 400/230V AC -35% to +35%	= measuring voltage 24V AC/DC; 230V AC 24V: -30% to +30% 230V: -30% to +20%	= measuring voltage 230V AC	= measuring voltage 3~ 208/120V to 480/277V AC -10% to +10%
Frequency range	48 – 63Hz	16.6 – 400Hz	16.6 – 400Hz or DC	48 – 63Hz	48 – 63Hz

### TIME CIRCUITS

ON delay	approx. 400ms	approx. 200ms	approx. 300ms	0.5 – 10s	approx. 500ms
Tripping delay (delay)	< 250ms	0.1 – 10s	0.1 – 10s	-	approx. 250ms
Response time short voltage interruptions	-	-	-	10 – 40ms	-

### OUTPUT CIRCUIT

Number of switch contacts	1 CO contact	1 CO contact	1 CO contact	1 CO contact	2 CO contacts
Max. switching capacity	2000VA (8A / 250V AC)				

### DESIGN

Dimensions (W×H×D)	22.5×67×76mm	22.5×67×76mm	22.5×67×76mm	22.5×67×76mm	45×67×76mm
Certificates	CE, cULus, EAC	CE, cULus, EAC	CE, cULus, EAC	CE, EAC	CE, cULus, EAC

Devices with Push-in terminal are not cULus listed.



MODEL	V2TF01	V2IM10 AL10	V4IM100 AL20 V4IM35 AL20	V4IA100 A	V4LM4S30
-------	--------	-------------	-----------------------------	-----------	----------

**ORDER INFORMATION**

PART NO screw terminal	2100100	2100400	2104401(100A) 2104402 (35A)	2104420	2104500
PART NO push-in terminal	2100110	2100410	2104410 (100A)	-	-

**FUNCTIONALITY**

O ... Over		■	■		10 functions selectable via rotary switch – for function overview pls. refer to page 25
U ... Under		■	■		
W ... Window		■	■		
2MAX ...2 Maximum			■		
MM ... Min. and max.			■		
+LATCH ... Error memory			■		
Temperature monitoring (PTC)	■				
Short circuit monitoring (PTC)	■				

**SWITCHING THRESHOLD**

Maximum	$\geq 3,6k\Omega$ (switch-off resistance)	10 – 100% of $I_N$	10 – 100% of $I_N$	-	sensitivity: 10k $\Omega$ – 500k $\Omega$ Vsense: 20, 40, 60, 80, 100%
Minimum	$\leq 1,6k\Omega$ (switch-on resistance)	5 – 95% of $I_N$	5 – 95% of $I_N$	-	sensitivity: 250 $\Omega$ – 12,5k $\Omega$ Vsense: 20, 40, 60, 80, 100%
Zero...Zero point	-	-	-	0%, 25%, 50% and 75% of nominal value	-
Zero Fine...Fine setting zero point	-	-	-	0 – 25% of nominal value	-
Span...Measuring span	-	-	-	25%, 50%, 75% and 100% of nominal value	-

**MEASURING CIRCUIT**

Measuring variable	temperature	current AC/DC AC sinus	current AC/DC AC sinus	current AC/DC AC sinus	liquid level with conductive probes (type SK1, SK5)
Measuring input	-	10A AC/DC	V4IM100AL20: 100A AC/DC built-in current transformer V4IM35AL20: 35A AC/DC built-in current transformer	100A AC/DC built-in current transformer	low (L): 250 $\Omega$ – 12,5k $\Omega$ high (H): 10k $\Omega$ – 500k $\Omega$

**SUPPLY CIRCUIT**

Supply voltage	24 – 240V AC/DC -15% to +10%	AC: 110 – 240V DC: 24 – 240V AC: -15% to +15% DC: -30% to +30%	24 – 240V AC/DC AC: -15% to +10% DC: -30% to +30%	AC: 48-240V DC: 24-240V AC: -10% to +10% DC: -15% to +20%	24-240V AC/DC AC: -10% to +10% DC: -25% to +25%
Frequency range	16.6 – 400 $\Omega$ or DC				

**TIME CIRCUITS**

ON delay	approx. 50ms	approx. 300ms	approx. 300ms	-	-
Start-up suppression time (start)	-	-	0 – 10s	-	-
Tripping delay (delay)	-	0.1 – 10s	0.1 – 10s	-	-
Delay (measuring filter)	-	-	-	-	1-10s

**OUTPUT CIRCUIT**

Analog output	-	-	-	0 ... 20 mA / 4 ... 20 mA 10 mA $\pm$ 10 mA / 12 mA $\pm$ 8 mA (burden: max. 300 $\Omega$ ) 0 ... 10 V 5 V $\pm$ 5 V (burden: max. 1,5k $\Omega$ )	-
Number of switch contacts	1 NO contact	1 CO contact	-	-	3 NO contacts
Max. switching capacity	2000VA (8 A / 250V AC)			-	1250VA (5A / 250V AC)

**DESIGN**

Dimensions (W×H×D)	22,5×67×76 mm	22,5×67×76 mm	45×67×76 mm	45×67×76 mm	45×67×76 mm
Certificates	CE, cULus, EAC			CE, EAC	CE, cULus, EAC

Devices with Push-in terminal are not cULus listed.

**GAMMA SERIES** MONITORING RELAYS



MODEL	G2PF400 VS02	G2PM400 VSY20	G2TF02	G2TFKN02	G2LM20
-------	--------------	---------------	--------	----------	--------

**ORDER INFORMATION**

PART NO 2 CO contacts	2390000	2390504 2390505 (24-240V AC/DC)	2390100 2390104 (230V AC) 2390111 (24-240V AC/DC)	2390101 2390110 (24-240V AC/DC)	2390201 (24V AC) 2390202 (110V AC) 2390200 (230V AC)
-----------------------	---------	------------------------------------	---	------------------------------------	--

**FUNCTIONALITY**

	3-phase AC voltage monitoring	3-phase AC voltage monitoring	temperature monitoring (PTC)	temperature monitoring (PTC)	level monitoring of conductive liquids
U ... Under		■			
W ... Window		■			
SEQ ... Phase sequence		■			
Phase failure	■	■			
ASYM ... Asymmetry	■	■			
Temperature monitoring (PTC)			■	■	
Short circuit monitoring (PTC)				■	
Zero-voltage latch (PTC)				■	
Test function (PTC)			■	■	
Pump up					■
Pump down					■

**SWITCHING THRESHOLD**

Maximum	-	-20 to +30% of $U_N$	$\geq 3.6k\Omega$ (switch-off resistance)	$\geq 3.6k\Omega$ (switch-off resistance)	-
Minimum	-	-30 to +20% of $U_N$	$\leq 1.6k\Omega$ (switch-on resistance)	$\leq 1.6k\Omega$ (switch-on resistance)	-
Asymmetry	fixed, typ. 30%	5 – 25%, OFF	-	-	-

**MEASURING CIRCUIT**

Measuring variable	3(N)~ AC sinus	3(N)~ AC sinus	temperature	temperature	liquid level via conductive probes
Measuring input	$U_N = 400/230V$ AC	3(N)~ 400/230V	-	-	0.25 – 100k $\Omega$

**SUPPLY CIRCUIT**

Supply voltage	= measuring voltage 3(N)~ 342 – 457V AC	24 – 240V AC/DC or selectable via power modules TR2, SNT2*	24 – 240V AC/DC; 230V fixed or selectable via power modules TR2, SNT2*	24 – 240V AC/DC or selectable via power modules TR2, SNT2*	24V AC 110V AC 230V AC
----------------	--	---	---	--	------------------------------

**TIME CIRCUITS**

Start-up suppression time (START)	fixed, max. 500ms	-	-	-	-
Tripping delay (delay)	fixed, max. 350ms	0.1 – 10s	-	-	0.5 – 10s
OFF delay	-	-	-	-	0.5 – 10s

**OUTPUT CIRCUIT**

Number of switch contacts	2 CO contacts	1 or 2 CO contacts	1 or 2 CO contacts	2 CO contacts	2 CO contacts
Max. switching capacity	1250VA (5A / 250V AC)				

**DESIGN**

Dimensions (W×H×D)	22.5×90×108mm				
Certificates	CE, cULus, EAC				

\* Please refer to the chapter accessories for detailed information and ordering data of power modules TR2 and SNT2.





MODEL	G2PU690 VS20	G2UM300 VL20	G2IM5 AL20	G2IM10 AL20	G2FW400 VL20
-------	--------------	--------------	------------	-------------	--------------

**ORDER INFORMATION**

PART NO 2 CO contacts	2390507	2390303 2390304 (24-240V AC/DC)	2390405 2390411 (24-240V AC/DC)	2390406 2390410 (24-240V AC/DC)	2390900
-----------------------	---------	------------------------------------	------------------------------------	------------------------------------	---------

**FUNCTIONALITY**

	3-phase voltage monitoring	1-phase AC/DC voltage monitoring	1-phase AC/DC current monitoring	1-phase AC/DC current monitoring	frequency monitoring
O ... Over		■	■	■	
U ... Under	■	■	■	■	
W ... Window		■	■	■	■
SEQ ... Phase sequence	■				
Phase failure	■				
ASYM ... Asymmetry	■				
+LATCH ... Error memory		■	■	■	■

**SWITCHING THRESHOLD**

Maximum	-	10 – 100% of $U_N$	10 – 100% of $I_N$	10 – 100% of $I_N$	$F_N = 50\Omega: 49 - 60\Omega$ $F_N = 60\Omega: 59 - 70\Omega$
Minimum	180 – 690V	5 – 95% of $U_N$	5 – 95% of $I_N$	5 – 95% of $I_N$	$F_N = 50\Omega: 40 - 51Hz$ $F_N = 60\Omega: 50 - 61Hz$
Asymmetry	fixed, 25%	-	-	-	-

**MEASURING CIRCUIT**

Measuring variable	3~ AC sinus	voltage AC/DC AC sinus	current AC/DC AC sinus	current AC/DC AC sinus	frequency 1-phase
Measuring input	$U_N = 208 - 690V$	30 / 60 / 300V AC/DC	20mA / 1A / 5A AC/DC *	100mA / 1A / 10A AC/DC	110 – 400V AC

**SUPPLY CIRCUIT**

Supply voltage	= measuring voltage 3~ 177V to 794V	24 – 240V AC/DC or selectable via power modules TR2, SNT2**	24 – 240V AC/DC or selectable via power modules TR2, SNT2**	24 – 240V AC/DC or selectable via power modules TR2, SNT2**	24 – 240V AC/DC
----------------	--	---	---	---	-----------------

**TIME CIRCUITS**

ON delay	-	-	-	-	0 – 10s
Start-up suppression time (start)	-	0 – 10s	0 – 10s	0 – 10s	-
Tripping delay (delay)	0.1 – 10s	0.1 – 10s	0.1 – 10s	0.1 – 10s	0.1 – 10s

**OUTPUT CIRCUIT**

Number of switch contacts	2 CO contacts	2 CO contacts	1 or 2 CO contacts	1 or 2 CO contacts	2 CO contacts
Max. switching capacity	1250VA (5A / 250V AC)				

**DESIGN**

Dimensions (W×H×D)	22.5×90×108mm				
Certificates	CE, cULus, EAC	CE, cULus, EAC	CE, cULus, EAC	CE, cULus, EAC	CE, EAC

\* For currents greater than 5A, matching current transformers are available as accessories and can be found on page 49. For power modules TR2 and SNT2 pls. s. page 46.

## KAPPA SERIES TIME DELAY RELAYS



MODEL	K3PF400 VSY02	K3YM400 VSY20	K3IM1 AACL20 K3IM5 AACL20	K3UM230 VAC02	K3UM24 VDC02
-------	---------------	---------------	------------------------------	---------------	--------------

### ORDER INFORMATION

PART NO	1380301	1380402	1380203 (1A) 1380202 (5A)	1380107	1380106
---------	---------	---------	------------------------------	---------	---------

### FUNCTIONALITY

	3-phase AC voltage monitoring	3- and 1-phase AC voltage monitoring	1-phase AC current monitoring	1-phase AC voltage monitoring	1-phase AC voltage monitoring
<b>O ... Over</b>			■		
<b>U ... Under</b>		■	■	■	■
<b>W ... Window</b>		■	■	■	■
<b>SEQ ... Phase sequence</b>	■	■			
<b>Phase failure</b>	■				
<b>ASYM ... Asymmetry</b>	■	■			
<b>+LATCH ... Error memory</b>			■		

### SWITCHING THRESHOLD

Maximum	-	80 – 130% of $U_N$	10 – 100% of $I_N$	80 – 120% of $U_N$	80 – 130% of $U_N$
Minimum	-	70 – 120% of $U_N$	5 – 95% of $I_N$	70 – 110% of $U_N$	75 – 125% of $U_N$
Asymmetry	5 – 30%, OFF	5 – 30%, OFF	-	-	-

### MEASURING CIRCUIT

Measuring variable	3(N)-AC sinus	3(N)-AC sinus	current AC sinus	voltage AC AC sinus	voltage AC
Measuring input	$U_N = 400/230V$ AC	$U_N = 400/230V$ AC	1A AC or 5A AC*	$U_N = 230V$ AC	$U_N = 24V$ DC

### SUPPLY CIRCUIT

Supply voltage	= measuring voltage 3(N)-400/230V AC -30% to +30%	= measuring voltage 3(N)-400/230V AC -30% to +30%	230V AC -15% to +10%	= measuring voltage 3(N)-400/230V AC -30% to +20%	= measuring voltage 24V DC -25% to +30%
Frequency range	48 – 63Hz	48 – 63Hz	48 – 63Hz	48 – 63Hz	-

### TIME CIRCUITS

Start-up suppression time (start)	-	-	0 – 10s	-	-
Tripping delay (delay)	fixed, approx. 100ms	0.1 – 10s	0.1 – 10s	-	-

### OUTPUT CIRCUIT

Number of switching contacts	2 CO contacts				
Max. switching capacity	1250VA (5A / 250V AC)				

### DESIGN

Dimensions (W×H×D)	38×51×80 mm				
Certificates	CE, EAC				

\* For currents greater than 5A, matching current transformers are available as accessories and can be found on page 49.

# Monitoring relays have a wide range of uses



## Fountain fill level

**WITH THE TELE E3LM10**, the fill level of the fountain is monitored with three sensors. With the water level too low, the current flow between the sensors is interrupted and the monitoring relay activates the pump. To prevent overflowing, the pump switches off when the third sensor comes into contact with the water.

## No flooding in the underground car park

**TELE LEVEL MONITOR V4LM** continuously controls a potential increase of the water level in the garage facilities. Once the connected sensors come into contact with ingressing water, the relay immediately activates pumps to drain the liquid and sends acoustic and optical warning signals.



## V-belt monitoring

**THE POWER FACTOR METER G2FW** quickly recognizes whether a V-belt has broken or if it has become loose. A tripping delay ensures that no fault messages or acoustic or optical warning signals are sent to the control system in the event of small deviations.



please scan QR code to see more monitoring relay applications





# Power Monitors

TELE power monitoring systems offer significant advantages, particularly in situations in which monitoring tasks are usually carried out by sensors:

## Benefits at a glance

- No problems due to contamination or measurement value drift of the sensors
- No maintenance and cleaning costs
- Easy to use, even in charged air or aggressive media
- Savings in terms of cabling
- No use of explosion-proof barriers necessary
- Reduction of error source
- Easy retrofitting

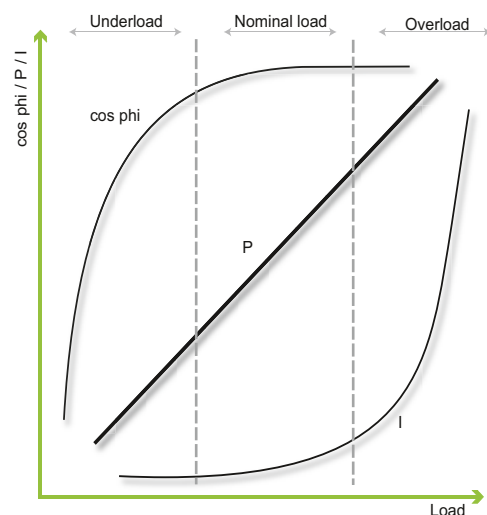

## CURRENT MONITORING RELAYS

Pure current measurements in the supply to motors can only be used in an extremely restricted capacity to monitor loads. This is due to three essential factors:

**01** In alternating current circuits, the measured current is apparent current. This total current comprises the sum of reactive and active current components. However, only the active current is relevant for the generation of mechanical power. The reactive current merely causes losses and does not contribute to the shaft power delivered.

**02** In an underload range the current does not reduce in a linear manner with the load but instead remains relatively high due to the necessary magnetisation current. Therefore, no relevant correlation exists between current and load.

**03** The current is dependent on the supply voltage. An undervoltage condition with a constant load can result in an increased current draw. To prevent such cases monitoring of the pure active current is insufficient.

This means that pure current monitoring is applicable only for extreme operating conditions, such as a drive blockage, because the current rises dramatically in such cases.

## POWER MONITORING SYSTEMS WITH POWER FACTOR MEASUREMENT ( $\cos \varphi$ )

The power factor  $\cos \varphi$  is the cosine of the phase shift angle between the current drawn and the voltage applied. For electrical motors this is dependent on the loading and theoretically equals 1 in an ideal case. In reality, the power factor at nominal load is practically in a range between 0.85 and 0.95.

In an underload range, the  $\cos \varphi$  monitor is extremely significant because the proportion of losses increases sharply at lower loads and results in a  $\cos \varphi$  of up to  $<0.5$  in an idle state. This is not applicable around the zero point and in an overload range because load changes cause only small changes of the phase shift angle  $\varphi$ .

## POWER MONITORING SYSTEMS WITH EFFECTIVE POWER MEASUREMENTS

The effective power measurement facilitates obtaining the most precise feedback regarding the state of an electrical motor because the effective power is proportional to the shaft power. A direct correlation exists between the effective power supplied and the motor loading (torque at constant rotational speed) across the entire working range.



### Examples for power monitor applications

- Waste compactors
- Crusher
- Agitators
- Conveyor belts
- Ventilation systems
- Machinery tools
- Bridge and portal cranes
- Centrifugal and piston pumps



G2CM400 V10 AL20



G2BA400 V12 A 4-20MA  
G2BA400 V12 A 0-10 V

MODEL

ORDER INFORMATION

PART NO

2390602

2390705  
2390708

FUNCTIONALITY

- O ... Overload monitoring
- U ... Underload monitoring
- W ... Window monitoring
- 2MIN ... Minimum monitoring
- 2MAX ... Maximum monitoring
- MIN/MAX ... Minimum- and maximum monitoring
- +LATCH ... Error memory
- I = 0 DETECTION ... Recognition of disconnected load
- Temp ... Temperature monitoring of the motor

cos φ power factor in  
1- or 3-phase mains

active power transducer in  
1- or 3-phase mains

	■	
	■	
	■	
	■	

SWITCHING THRESHOLD

- Zero ... Zero point
- Zero Fine ... Fine setting zero point
- Span ... Measuring span
- Threshold P / P1
- Threshold P2

	-	0%, 25%, 50% and 75% of nominal value
	-	0 – 25% of nominal value
	-	100%, 75%, 50% and 25% of nominal value
	cos φ Max: 0.2 – 1.0	-
	cos φ Min: 0.1 – 0.99	-

MEASURING CIRCUIT

- Measuring variable
- Measuring range
- Measuring input voltage
- Overload capacity voltage
- Measuring input current \*
- Overload capacity current

	power factor (cos φ), 1- or 3-phase loads AC sinus	true power, 1- or 3-phase loads AC sinus
	0.1 – 1	0.75 kW • 1.5 kW • 3 kW • 6 kW
	40 – 415 V AC (single-phase) 40/23 to 415/240 V (3 ~)	0 – 480 V AC (single-phase) 0 to 480/277 V (3 ~)
	500 V AC (single-phase) 500/289 V (3 ~)	550 V AC (single-phase) 550/318 V (3 ~)
	0.5 – 10 A	0 – 6 A (0.6 and 1.2 kW) 0 – 12 A (2.4 and 4.8 kW)
	11 A permanent	12 A permanent

SUPPLY CIRCUIT

Supply voltage

selectable via power module TR2 or SNT2

24 – 240 V DC; 48 – 240 V AC

TIME CIRCUITS

- Start-up suppression time (start)
- Tripping delay (delay)

	1 – 100 s	-
	0.1 – 40 s	-

INPUT CIRCUIT

Control input

	-	-
--	---	---

OUTPUT CIRCUIT

- Analog output
- Number of switch contacts
- Max. switching capacity

	-	4 – 20mA (Burden: max. 500 Ω) 0-10V (Burden: min. 3k Ω)
	2 CO contacts	-
	1250 VA (5 A / 250 V AC)	-

DESIGN

- Dimensions (W×H×D)
- Certificates

	22.5×90×108 mm	22.5×90×108 mm
	CE, cULus, EAC	CE, EAC

\* For higher currents, the corresponding current transformers can be used as accessories, whereby the smaller measuring range must always be used for the device. For current transformers please see page 49. Power modules TR2, TR3 and SNT2 can be found on page 46.



G2BM400 V12 AL10  
G2BM400 V12 AFL10



G4CM690 V16 ATL20



G4BM480 V12 ADTL20

2390700 2390702	2394600	2394706 (24-240V AC/DC) 2394700
true power monitoring in 1- or 3-phase mains	cos φ power factor in 1- or 3-phase mains	true power monitoring in 1- or 3-phase mains
■ ■	■ ■ ■ ■ ■ ■	■ ■ ■ ■ ■ ■ ■
-	-	-
-	-	-
-	-	-
5 – 120% of P <sub>N</sub>	cos φ 1: 0,3 – 1 (inductive) 1 – 0,3 (capacitive)	2.5kW: 120 – 2490W 10kW: 480 – 9960W
-	cos φ 1: 0,3 – 1 (inductive) 1 – 0,3 (capacitive)	-
true power, 1- or 3-phase loads AC sinus	power factor (cos φ), 1- or 3-phase loads AC sinus	true power, 1- or 3-phase loads AC sinus
0.5kW • 1kW • 2kW • 4kW	0.3 – 1	2.5kW • 10kW
0 – 230V AC (single-phase) 0 – 415/240V (3 ~)	85 – 690V AC (single-phase) 85 – 690/400V (3 ~)	0 – 480V AC (single-phase) 0 – 480/277V (3 ~)
300V AC (single-phase) 500/289V (3 ~)	796V AC (single-phase) 796/460V (3 ~)	550V AC (single-phase) 550/318V (3 ~)
0 – 6A (0.5 and 1kW) 0 – 12A (2 and 4kW)	1 – 8A 1 – 16A	0.15 – 6A (2.5kW) 0.3 – 12A (10kW)
12A permanent	20A permanent	12A permanent
selectable via power module TR2 or SNT	selectable via power module TR3	24 – 240V AC/DC or selectable via power module TR3
1 – 100s (AL10) 0.1 – 2 s (AFL10)	3 – 180s	0 – 100s
0.1 – 50s (AL10) 0.1 – 2 s (AFL10)	1 – 50s	0.1 – 50s
Y1-Y2 (Latch)	Y1-Y2 (Latch)	Y1-Y2 (Latch)
-	-	-
1 CO contact	2 CO contacts	2 CO contacts
1250VA (5A / 250V AC)	1250VA (5A / 250V AC)	1250VA (5A / 250V AC)
22.5×90×108mm	45×90×108mm	45×90×125mm
CE, cULus, EAC	CE, cULus, EAC	CE, cULus, EAC



# TELE SensAct



The new, compact, monitoring modules with ModBus RTU interface, for highly accurate and reliable measurement generate many measured values for a PLC or other master devices.

TELE introduces a new range of communication-capable monitoring devices with ModBus RTU interface with the focus on electric energy applications and monitoring of key electrical values in industrial plants. The modules reliably measure current / voltage / power / energy and various other electrical values in single or three phase networks and supply the data via ModBus RTU to a PLC or other data logger. The fast measurement cycle and fast responding data transmission gives the operator a clear overview of the condition of his system. These accurate process data enable process specialists to adapt maintenance intervals accordingly and help to avoid costly unscheduled downtimes.

### 3-PHASE POWER METER WITH MODBUS RTU

The 3-phase power meter with ModBus RTU is a complete three phase power meter housed in a 17.5mm wide module and supports the connection of

most common current transformers (1 or 5A, 333 mV, Rogowski probes). It measures the power (active / reactive / apparent power, bidirectional energy, RMS values, frequency, power factor) in three-phase supply networks. The device is available in three different versions for various applications from standard measurement to power quality requirements.

### 1-PHASE POWER METER AC/DC WITH MODBUS RTU

The 1-phase power meter AC/DC with ModBus RTU measures DC current up to 50A/300A and DC voltage up to 1000V. With the same device you can measure both current and voltage for different applications in the fields of renewable energy, building automation or mobility. Thanks to the built-in interface converter RS485 Modbus RTU, data is available directly at the datalogger without any other hardware or software.





**3-phase power meter with ModBus RTU**

*Installation design*

Up to 500V P-P and universal CT input with ModBus RTU / RS485 interface and programmable digital switch in one module size (17,5mm). Version S1XMmHM also includes harmonic analysis up to 63rd, THD, I/ V peak. Advanced software and energy counter.



**1-phase AC/DC current transformer with ModBus RTU**

*Converter design*

AC up to 50A or up to 300A and DC up to 50A or up to 400A with ModBus RTU / RS485 interface, DIN rail mounting, frequency range DC or 1 to 400Ω; measurements: Irms, Vrms, Watt, VAR, VA, Vpk, Ipk, frequency, Cos φ, energy bidirectional, THD voltage versions: 800V AC / 1000V DC or 80V AC / 100VDC



**1-phase universal current/voltage converter with ModBus RTU**

*Installation design*

Universal sensor input, analog output and RS485 ModBus RTU, RMS, AC and DC measurement, min/max and average measurement, frequency and crest factor measurement, temperature and resistance measurement (PT100 or NTC) and internal temperature measurement.



**1-phase AC/DC current transformer with ModBus RTU**

*Converter design*

TRMS measurement up to 50A or up to 300A, frequency range DC or 20...2000Hz, bipolar, analog 0-10V and serial output ModBus RTU/ RS485, adjustable range by dip switch or RS485, DIN rail mounting horizontal or vertical.



**Serial converter USB-RS485 (isolated up to 5kV)**

*USB*

The S-USB485 is a serial converter isolated up to 5 kV, with software functions based on a USB FTDI chip. Windows validated drivers download automatically when your PC is online. This device connects safely to any ModBus device on RS485.



MODEL	S1MMA500 VM	S1MMA500 VLM	S1MMA500 VHM	S6XM50 A1000 VM	S6XM50 A100 VM
-------	-------------	--------------	--------------	-----------------	----------------

**ORDER INFORMATION**

PART NO	2800300	2800310	2800320	2800200	2800210
---------	---------	---------	---------	---------	---------

**INTERFACE**

ModBus RTU	■	■	■	■	■
ModBus RTU on T-Bus	■	■	■		
Analog 4-20mA					
Analog 0-10V					
Digital out	■	■	■		

**FUNCTIONALITY**

3-ph power meter	3-ph power meter	3-ph power meter	3-ph power meter	1-ph power meter	1-ph power meter
------------------	------------------	------------------	------------------	------------------	------------------

**MEASUREMENT RANGE**

Current AC	ext.CT/Hall/Rogowski	ext.CT/Hall/Rogowski	ext.CT/Hall/Rogowski	50A	50A
Current DC	333mV	333mV	333mV	50A	50A
Voltage AC	500V P-P	500V P-P	500V P-P	800V	80V
Voltage DC	-	-	-	1000V	100V

**MEASUREMENT VALUES**

Irms	■	■	■	■	■
Idc				■	■
Iac					
Ah on Irms					
Ah on Idc					
Ah on Iac					
Vrms	■	■	■	■	■
Vdc				■	■
Power/ reactive power/ apparent power	■	■	■	■	■
Cos φ	■	■	■	■	■
Distorted power factor		■	■		
Tan φ		■	■		
Active energy bidirectional	■	■	■	■	■
Reactive/ Apparent energy bidirectional	■	■	■		
Ipeak / Vpeak	■	■	■	■	■
Frequency	■	■	■		
Crest factor	■	■	■		
Temperature (PT100 / NTC)					
Resistance (of PT100 / NTC)					
Internal temperature		■	■		
Min, Max values		■	■	■	■
Average values		■	■		
THD		■	■	■	■
TDD		■	■		
Phase sequence monitoring		■	■		
Time above threshold for power		■	■		
Inverter input (PWM modulated)			■		
Harmonic analysis up to 63rd			■		
Interharmonics			■		
Sag			■		
Swell			■		
Interruption			■		
Waveform display			■		
1-ph device efficiency measurement			■		
Certificates		CE		CE, cULus	CE





# Grid and system protection



Autonomously working disconnecting unit for small power plants

## WHY?

In the event of a network shutdown or network disruption, small power plants must be disconnected from the grid immediately to avoid any danger to people and machinery.

## FUNCTION

An automatic disconnection device monitors the feed-in of energy to the 230/400V grid. In case of a power failure or disruption by the energy supplier it is vital for small power plants to be disconnected within a few milliseconds. Voltage- and frequency monitoring as well as island operation detection are the main requirements for an automatic disconnection device.

## REQUIREMENT

Converting renewable energy into electricity is a key element in stabilizing the global climate. In the context of small and micro power plants we mainly see

photovoltaic installations, small wind power generators, cogeneration plants or small hydropower plants being used. The energy obtained is used to cover own consumption or increasingly fed into the public low-voltage grid at a profit. To ensure network safety, an automatic interface monitors the transfer between small power plants and the grid of the energy supplier (ES). Large power plants are managed and monitored directly by the ES using telecontrol technology. Yet, this method is too expensive and therefore uneconomical for many small electricity producers.

In the event of a power cut or a disruption in the grid of the energy supplier, small power plants have to be disconnected immediately from the public grid to prevent unwanted feed-in, and to protect maintenance personnel and consumers from risk of improper voltages and frequencies. Monitoring and automatic disconnection are carried out by an automated

interface. Small power plants must be equipped with an automatic isolation unit that is checked and permitted by an accredited authority. Country-specific norms define in-depth how the interface must be constructed and certified. To meet requirements of the energy supply companies' standards the market offers solutions as individual components, multinational components as well as integrated solutions. If required

by the network operator, the thresholds can be adjusted even outside of standard values. Functionally safe devices also fulfil the monitoring function in the event of faults, detect these faults and ensure safe operating conditions.

TELE's NA003-M64 offers an optimal solution for each country and any requirement.

✓ **Multifunctional device**

✓ **Open setup, fully configurable without any limitations**

✓ **One device for low and medium voltage grid**



Wind power plant



Hydro power plant



Combined heat and power plant



Biomass power plant

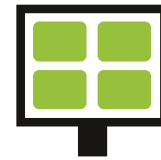

Photovoltaics



Battery storage

MODEL: NA003-M64

PART NO: 2700100 A

**FUNCTIONALITY**

Implemented standards

Complies with new and previous standards which makes replacement of existing installations fast and easy.

Predefined parameter settings for several countries.

**Check all available standards and settings by scanning the QR Code:**



Measuring variable

phase to phase voltage, phase to neutral voltage, 10 minutes voltage average, frequency, frequency change (RoCoF), phase shift (PShift)

Measuring range

phase to phase voltage: 0 ... 560VAC, phase to neutral voltage: 0 ... 325VAC  
frequency: 40 ... 60Hz, RoCoF 100mHz/s ... 2.000mHz/s, Pshift 1 ... 15°

Monitoring functions

- 2× phase to neutral overvoltage
- 2× phase to neutral undervoltage;
- 2× phase to phase overvoltage
- 2× phase to phase undervoltage;
- 1× 10 minutes voltage average (over)
- 4× overfrequency, 4× underfrequency, 1× random overfrequency
- 1× RoCoF (over), 1× PShift (over)

Features

- each turn-off threshold is associated with its own turn off time
- fixed turn-on time, random turn-on time
- configurable feedback contact evaluation
- enable / disable functions via digital inputs
- enable / disable functions via selectable mode
- 4 different connection and measuring modes: 2 wire (single phase L1, N); 3 wire (3 phase without N); 4 wire (3 phase LL only); 4 wire (3 phase LL + LN)
- configurable nominal voltage
- functional safety
- password protection and sealing capability
- error memory with time stamp (entries)

Supply voltage

24V DC ± 10%,  
110 ... 240V AC ± 30%,

Rated frequency

50/60Hz or DC

Tolerance of rated frequency

48...63Hz

Output circuit

3 CO contacts 5A, 250V AC (1250VA)

Digital inputs

5 inputs for potential free contacts (24V / 5mA)

**DESIGN**

Dimensions (W×H×D)

106.3×90.5×62mm

Certificates

CE, EAC

# Accessories

For our timing- and monitoring relays, power monitors and grid- and system protection we offer the following accessories.



Timing relays



Monitoring relays



Power monitors



Grid and system protection

TR2, TR3, SNT Series power modules for transforming the supply voltage to the internal operating voltage of GAMMA relays

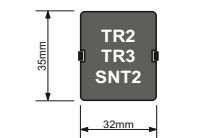

Design A  
(TR2, SNT2) for Gamma G2

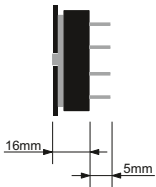

Design B  
(TR3) for Gamma G4

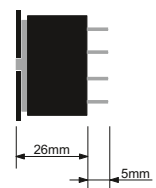

MODEL	SUPPLY VOLTAGE	TOLERANCE	POWER INPUT P <sub>IN</sub>	POWER OUTPUT P <sub>OUT</sub>	DESIGN	PART NO
SNT2 - 24V DC	24V DC	20.4 - 26.4V	2VA	0.5VA	A	282050
TR2 - 24V AC	24V AC	20.2 - 26.4V	2VA	0.5VA	A	282110
TR3 - 24V AC	24V AC	20.4 - 26.4V	4VA	1.5VA	B	285010
TR2 - 42V AC	42V AC	36 - 46V	2VA	0.5VA	A	282111
TR2 - 48V AC	48V AC	41 - 53V	2VA	0.5VA	A	282112
TR2 - 110V AC	110V AC	94 - 121V	2VA	0.5VA	A	282113
TR3 - 110V AC	110V AC	94 - 121V	4VA	1.5VA	B	285013
TR2 - 127V AC	127V AC	108 - 140V	2VA	0.5VA	A	282114
TR2 - 230V AC	230V AC	195 - 264V	2VA	0.5VA	A	282120
TR3 - 230V AC	230V AC	184 - 264V	4VA	1.5VA	B	285025
TR2 - 400V AC	400V AC	340 - 456V	2VA	0.5VA	A	282117
TR3 - 400V AC	400V AC	323 - 456V	4VA	1.5VA	B	285017
TR2 - 440V AC	400V AC	374 - 484V	2VA	0.5VA	A	282119
TR3 - 440V AC	440V AC	374 - 484V	4VA	1.5VA	B	285019
TR3 - 500V AC	500V AC*	425 - 550V	4VA	1.5VA	B	285026

\* May only be used with types G4PM and G4BM!

Remote Potentiometer RONDO Series frontpanel mounting adjusting values of intended timers and thyristor control units remotely.



R2

MODEL	SCALE	DIMENSIONS (W × H × D)	CONNECTIONS	PART NO
R2 1MΩ 0.1	0,1 – 1	Ø 28 (Ø 22*)×53 mm	1 = First 2 = Wiper 3 = Finish	282130
R20 10KΩ	0 – 10			282131

\* diameter front panel mounting

Probes – SK Series for monitoring level of conductive liquids

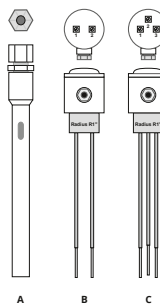

MODEL	TYPE	MEASURING VOLTAGE	MAX. TEMP.	NUMBER OF ELECTRODES	LENGTH	DESIGN	PART NO
SK1	immersion probe	max. 24V AC	60°C	1	140mm	A	190107
SK2	rod probe		90°C	2	500mm	B	190108
SK3-500			90°C	3	500mm	C	190109
SK3-1000			90°C	3	1000mm	C	190110

Front Cover FA-G2 for GAMMA monitoring relays (width 22.5mm)

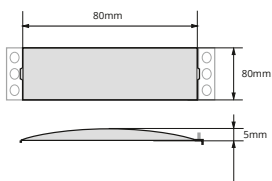

MODEL	Ø DRILL HOLES	DIMENSIONS (W × H × D)	PART NO
FA-G2	Sealable front cover for protecting GAMMA devices against unintended or unauthorized changes in setup parameters.	22.5×80×5mm	070160

# Complementary products

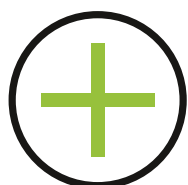

In addition to our product range we offer the following complementary products:

## Current transformers

- Baffle-type current transformer series: WSW [\[page 49\]](#)
- Bar-type current transformer series: DSW [\[page 49\]](#)

## Coupling units

- Coupling relay series: ENYA [\[page 50\]](#)
- Automatic-manual-OFF relay series: OCTO [\[page 50\]](#)
- Analog data encoder series: OCTO [\[page 50\]](#)
- Levelswitch series: OCTO [\[page 50\]](#)

## Switching relays

### Sets

- Interface relay series: STKR and SKR [\[page 51\]](#)

### Accessoires

- Miniature relay series: RA and RM [\[page 51\]](#)
- PCB relay series: RP [\[page 51\]](#)
- Industrial relay series: RT [\[page 52\]](#)
- Multifunction time module series: COMBI [\[page 52\]](#)

## Softstarter

### Braking units

- Motor starter series: P4.0 [\[page 54\]](#)

### Thyristor control units

- Thyristor switch (SSR) series: GTS [\[page 56\]](#)
- Fuse and fuse holders [\[page 56\]](#)

## Hour meters

### Digital time switches

- Hour meter series: TBG and TBW [\[page 57\]](#)

### Countdown timer

- Digital time switch series: TSC [\[page 57\]](#)
- Countdown timer series: TTC [\[page 57\]](#)

## DC power supplies

- Switching power supplies [\[page 58\]](#)



MODEL	RATED POWER	RATED PRIMARY CURRENT	SECONDARY CURRENT	DIMENSIONS	CLASS	PART NO
WSW 60 1 A/5A 2,5VA	2,5VA	1A	5A	80×60×30 mm	1	498060
WSW 60 5 A/5A 2,5VA	2,5VA	5A		80×60×30 mm		498062
WSW 60 10A/5A 2,5VA	2,5VA	10A		80×60×30 mm		498063
WSW 60 15 A/5A 2,5VA	2,5VA	15A		80×60×30 mm		498064
WSW 60 20A/5A 2,5VA	2,5VA	20A		80×60×30 mm		498065
WSW 60 25 A/5A 2,5VA	2,5VA	25A		80×60×30 mm		498066
WSW 60 30A/5A 2,5VA	2,5VA	30A		80×60×30 mm		498067
WSW 60 40A/5A 2,5VA	2,5VA	40A		80×60×30 mm		498068
DSW 60 50 A/5A 1,25VA	1,25VA	50A		50,5×50,5×85 mm	3	498069
DSW 60 75 A/5A 2,5VA	2,5VA	75A		50,5×50,5×85 mm		498071
DSW 60 100A/5A 2,5VA	2,5VA	100A		33×33×50 mm	1	498073
DSW 60 150A/5A 3,75VA	3,75VA	150A		33×33×50 mm		498075
DSW 60 200A/5A 5VA	5VA	200A		33×33×50 mm		498076
DSW 60 250A/5A 5VA	5VA	250A		33×33×50 mm		498077
DSW 60 300A/5A 5VA	5VA	300A		33×33×50 mm		498078

ACCESSORIES

DESCRIPTION

PART NO

MC-SW (2 pcs)

Mounting clip required for mounting the current transformer on DIN-Rail TS 35

498100

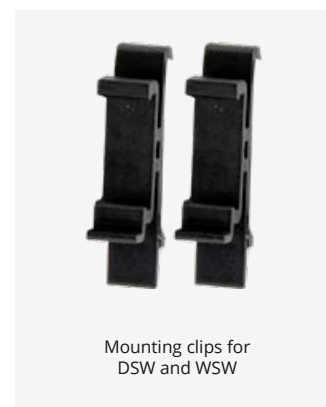

## COMPLEMENTARY PRODUCTS

ENYA Series coupling units / OCTO Series coupling units



MODEL	E1K16A	E1K E3K	HAR1	OVP1	OCP1	OVL1	OCL1
<b>ORDER INFORMATION</b>							
PART NO	110701	110700 (E1K) 111700 (E3K)	170010	170012	170018	170015	170017
FUNCTIONALITY	coupling relays	coupling relays	automatic manual off relay	analog data encoder	analog data encoder	level switch	level switch
Coupling unit	■	■					
AUTO ... Automatic			■	■	■	■	■
0 ... OFF			■	■	■	■	■
HAND ... Manual			■	■	■	■	■
<b>SUPPLY CIRCUIT</b>							
Supply voltage	24 – 240V AC/DC	24 – 240V AC/DC (E1K) 12 – 240V AC/DC (E3K)	24V AC/DC	24V AC/DC	24V AC/DC	24V AC/DC	24V AC/DC
Rated frequency	48 – 63Hz						
<b>INPUT CIRCUIT</b>							
Control voltage	-	-	24V AC/DC	-	-	-	-
Analog input DC	-	-	-	0 – 10V	0 – 20 mA	0 – 10V	0 – 20 mA
Trigger level DC	-	-	-	0 – 10V	0 – 20 mA	1 – 10V	2 – 20 mA
<b>CHECKBACK</b>							
Number of checkback contacts	-	-	1 NO contact	1 NO contact	1 NO contact	1 NO contact	1 NO contact
Min. switching capacity	-	-	5 mVA (1mA / 5V)	5 mVA (1mA / 5V)	5 mVA (1mA / 5V)	5 mVA (1mA / 5V)	5 mVA (1mA / 5V)
Max. switching capacity	-	-	24VA (500mA / 48V)	56VA (2A / 28V)	56VA (2A / 28V)	56VA (2A / 28V)	56VA (2A / 28V)
<b>OUTPUT CIRCUIT</b>							
Number of switching contacts	1 NO contact	1 CO contacts (E1K) 2 CO contacts (E3K)	1 CO contact	-	-	1 CO contact	1 CO contact
Max. switching capacity AC	4000VA (16A / 250V)	2000VA (8A / 250V)	2000VA (8A / 250V)	-	-	2000VA (8A / 250V)	2000VA (8A / 250V)
Analog output	-	-	-	0 – 10V DC	0 – 20 mA	-	-
<b>DESIGN</b>							
Dimensions (W x H x D)	17.5×87×65 mm	17,5×87×65 mm (E1K) 35×87×65 mm (E3K)	17.5×87×70 mm	17.5×87×70 mm	17.5×87×70 mm	17.5×87×70 mm	17.5×87×70 mm
Certificates	CE, EAC						



SKR, STKR Series and Accessories PLC coupling relays



SKR

MODEL	FUNCTION	RATED VOLTAGE		RELAY VOLTAGE	NUMBER OF SWITCHING CONTACTS	PACKAGING UNIT	PART NO
SKR 524	PLC coupling relay unit	24V	AC/DC		1 CO contact	10	180501
SKR 024		24V	DC				180500
SKR 730		230V	AC				180502
STKR 524	PLC coupling relay modular	24V	AC/DC	24V DC			180504
STKR 024		24V	DC	24V DC			180503
STKR 615		115V	AC/DC	60V DC			180506
STKR 730		230V	AC	60V DC			180505
RM699V-3011-85-1024	relay for STKRww	24V	DC				20
RM699V-3011-85-1060		60V	DC		20	100661	

ACCESSORIES

	FUNCTION	COLOR	NUMBER OF POLES		
PB-B SKR	jumper link	blue	20	10	180535
PB-R SKR		red			180536

RA, RM Series miniature relays / RP Series PCB relays



RA



RM



RP

MODEL	RATED VOLTAGE		LED	NUMBER OF SWITCHING CONTACTS	PACKAGING UNIT	PART NO
RA 524L-N	24V	AC	■	2 CO contacts	10	100623LD-N
RA 615L-N	115V		■			100621LD-N
RA 730L-N	230V		■			100624LD-N
RA 012L-N	12V	DC	■			100625LD-N
RA 024L-N	24V		■			100622LD-N
RM 512L-N	12V		■			100612LD-N
RM 524L-N	24V	AC	■	4 CO contacts	10	100613LD-N
RM 615L-N	115V		■			100618LD-N
RM 730L-N	230V		■			100619LD-N
RM 012L-N	12V	DC	■			100601LD-N
RM 024L-N	24V		■			100603LD-N
RM 048L-N	48V		■			100602LD-N
RM 220L-N	220V		■	100620LD-N		
RP 524-1	24V	AC		1 CO contacts	20	100431
RP 730-1	230V					100432
RP 024-1	24V	DC				100430
RP 524-2	24V	AC		2 CO contacts		100417
RP 730-2	230V					100418
RP 012-2	12V	DC				100420
RP 024-2	24V			100416		

## COMPLEMENTARY PRODUCTS

### RT Series industrial relays

MODEL	RATED VOLTAGE	LED	RECOVERY DIODE	GOLD-PLATED CONTACTS	NUMBER OF SWITCHING CONTACTS	PACKAGING UNIT	PART NO
RT 1.2.012L	12V	AC	■		2 CO contacts	10	100508LD
RT 1.2.024L	24V		■				100507LD
RT 1.2.110L	110V		■				100505LD
RT 1.2.230L	230V		■				100502LD
RT 2.2.012L	12V	DC	■				100517LD
RT 2.2.024L	24V		■		100516LD		
RT 1.3.024L	24V	AC	■		3 CO contacts		100526LD
RT 1.3.048L	48V		■				100524LD
RT 1.3.110L	110V		■				100522LD
RT 1.3.230L	230V		■				100521LD
RT 1.3.230.02L	230V			■		100521H	
RT 2.3.012L	12V	DC	■			100536LD	
RT 2.3.024L	24V		■		100535LD		
RT 2.3.024LD	24V		■	■		100535FD	
RT 2.3.024.02LD	24V		■		■	100535H	
RT 2.3.048L	48V		■			100533LD	

### COMBI Series multifunction timing module for industrial relays with socket type ES9 and PF113BEM (ES12)

MODEL	FUNCTIONS	TIME RANGES	SUPPLY VOLTAGE	NUMBER OF SWITCHING CONTACTS	DIMENSIONS (W × H × D)	CERTIFICATES	PACKAGING UNIT	PART NO
COM3T	8 E, R, Ws, Wa, Wu, Es, Bp, Bi	8 (0.05s - 10 d)	24 - 240V AC/DC	2 or 3 CO contacts (according to selected industrial relay)	35 × 12 × 47 mm	CE, cULus	20	237010



RT

+



COM3T

+



Socket

→



RT + COM3T + Socket



Sockets for switching relays

MODEL	MODULES USABLE	TYPE OF CONNECTION	FOR RELAYS	RATED VOLTAGE	PACKAGING UNIT	PART NO		
PYF14BE (ES 15/4N)	yes (pls. s. table below)	screw terminal	RA, RM	300V	AC	10		
PYF14BE3 (ES 15/4S)								
PYF14BE3CC (ES 15/4G)		push-in terminal						
CST-B14F2-L (ES 15/4B)								
RSS214		screw terminal	RM					
PI50BE/3R (ES 50/3)								
PI50BE/3CC (ES 50/3G)		push-in terminal	RP			20		
PI50BE (ES 50)								
PSS8/3		screw terminal					RT 8-pin	10
PF083BE (ES8)								
ES 9	yes (pls. s. table below)		RT 11-pin	180041				
PF113BEM (ES12)								
PF113BE (R11X)	no		1 or 10*	180155				

\* For KAPPA series also available as single packaging unit.



COM3T + ES9 + RT1.2.012L



Socket PYF14BE (ES 15/4N)



Socket PSS8



Socket PYF14BE3CC (ES 15/4G)



Socket PF113BE (R11X)

Modules and Accessories for switching relays

MODEL	TYPE DESCRIPTION	FOR SOCKETS SERIES	FOR SWITCHING RELAYS SERIES	RATED VOLTAGE	PACKAGING UNIT	PART NO
M21N	diode	PYF, CST, PI	RA, RM, RP	6 – 230V DC (+A1)	20	180261
M41R	LED (red) + diode	PYF, CST, PI	RA, RM, RP	6 – 24V DC (+A1)		180263
EM 12	LED (green) + diode	RSS214, PSS8	RA, RM, RP	6 – 24V DC (+A1)	10	180309
EM 03	RC-link	RSS214, PSS8	RA, RM, RP	110 – 230V AC		180300
TYPE41 (TVL1)	LED + diode	PF113BEM, ES9	RT	6 – 24V DC (+A1)	20	180232
TYPE21 (TVD1)	retaining clip (metal)	PF113BEM, ES9	RT	6 – 230V DC (+A1)		180230
HB/RM-RA	retaining clip (plastic)	PYF, CST, RSS214	RA, RM		25	180032
HB/ES15	retaining clip (metal)	PYF, CST	RA, RM		10	180153
HB/RT	retaining clip(plastic)	PF, ES9	RT			180043
HB/RP 16	retaining clip (plastic)	PI50	RP		20	180029
HB/PSS	retaining clip (plastic)	PSS8/3	RP		10	180060
BS/PSS	front cover (label field)	PSS8/3	RP			180057



# Motor Starter P-4.0

22,5 mm compact motor starter  
including motor protection

## FUNCTIONALITY

Today's drive solutions require powerful and flexible equipment solutions. The compact motor starter P-4.0 from TELE can be used for motors up to 4.0kW @ 400V and includes 5 functions in one compact unit, measuring only 22,5mm in width. This intelligent instrument offers soft start, soft stop, forward/reverse, current protection and electronic motor protection.

Thanks to the integrated motor protection plus isolation relays, separate MCB devices are not required. A simple circuit breaker protects the

installation against short circuit and faulty wiring. The soft start and stop function is performed by semiconductors (thyristors) and the reversing function by internal relays, operated in the standstill phase. After performing the start/stop function the semiconductors are bypassed by integrated relays to minimize power dissipation. The intelligent combination of semiconductors and relays increases lifetime and efficiency of the product. The integrated current limit protects motors, shafts and plants from mechanical stress and reduces maintenance and downtimes.

### Technical features

- Forward/Reverse of 3-ph ac motors 3 AC 480 V / 9 A, equals 4.0kW @ 400VAC
- Integrated reversing unit
- 2-ph control for softstart and stop
- Integrated bypass relays
- 3 pots for adjustment of torque, time and max. current
- 4 LEDs indicate status and error
- Reset button on front and external reset available
- Dimension in mm (W×H×D): 22,5×105×120,3
- Article number:  
490800 (F/R + blocking protection)  
490801 (F/R + motor protection + isolation contactor)

### Your advantages

- Up to 5 functions in one device
- Forward/Reverse, soft start, current limit, motor protection, soft stop
- Compact design, only 22.5mm in width
- Simple commissioning and easy operation
- Robust semiconductors with 1500V max. isolation voltage
- Increased system availability by motor protection function
- Increased lifetime by hybrid design compared to relay solution
- Energy saving by bumpless soft start/stop function and bypass relay

### Applications

- Reversing drive for door, lifting and transport application with blocking protection
- Transport systems (belts and rollers) with blocking protection
- Motorized valves in process applications (chemical and petrochemical, power generation plants)
- Pumps and fans
- Switching of 3 ph transformers
- ... and a lot of other applications with sophisticated drive requirements

### Advantage of power control with semiconductors

- Switching without any wear
- Extended lifetime
- Frequent start / stop event
- Low space requirement
- Fast switching
- Suitable for industrial environment

### Functions

- Reversing direction (forward / return)
- Softstart / Softstop
- Overcurrent protection
- Motorprotection (option)
- Isolation relays (option)

MODEL	FUNCTIONALITY	MOTOR CONTROL	NOMINAL CURRENT	NOMINAL MOTOR POWER	DIMENSIONS (W × H × D)	CERTIFICATES	PART NO
P-4.0/RL/OL	forward/reverse, soft start, current limit, blocking protection, soft stop	2-phase	9A	4kW	22.5×105×120.3mm	CE, cULus (listing pending)	490800
P-4.0/RL/TP/IC	forward/reverse, soft start, soft stop, motor protection + isolation contactor	2-phase	9A	4kW	22.5×105×120.3mm	CE, cULus (listing pending)	490801

## COMPLEMENTARY PRODUCTS

**GTF Series** digital thyristor control unit (compact design, digital configurable)



GTF

MODEL	AUXILIARY VOLTAGE	NOMINAL VOLTAGE	NOMINAL CURRENT	FAN	INTERNAL FUSE	OPERATING MODE	DIMENSIONS (W × H × D)	PART NO
GTF-25-480-0-0-0-0 1-P-M	24V AC/DC	480V AC *	25A			phase clipping control (other operating modes configurable)	60×136,5×143mm	493100
GTF-40-480-0-0-0-0 1-P-M			40A				60×136,5×143mm	493105
GTF-50-480-0-0-0-0 1-P-M			50A				80×136,5×143mm	493108
GTF-60-480-0-0-0-0 1-P-M			60A				80×136,5×143mm	493111
GTF-75-480-0-0-0-0 1-P-M			75A				127×136,5×143mm	493121
GTF-90-480-0-0-0-0 1-P-M			90A				127×136,5×143mm	493131
GTF-120-480-0-0-0-0 1-P-M			120A	■			127×150,5×143mm	493141
GTF-150-480-0-0-1-0 1-P-M			150A	■	■		108,3×302×170,4mm	493152
GTF-200-480-0-0-1-0 1-P-M			200A	■	■			493161
GTF-250-480-0-0-1-0 1-P-M			250A	■	■			493171
Configuration cable + software								493090

\* other nominal voltages upon request

**GTS Series** thyristor switch (compact design, operating mode zero point switch)



GTS

MODEL	NOMINAL VOLTAGE	NOMINAL CURRENT	CONTROL INPUT	FAN	DIMENSIONS (W × H × D)	PART NO
GTS-15/48-D-0	480V AC *	15A	6 – 32V DC		24×100×107mm	493010
GTS-25/48-D-0		25A			24×100×107mm	493005
GTS-40/48-D-0		40A			35×100×142mm	493003
GTS-50/48-D-0		50A			60×100×142mm	493001
GTS-60/48-D-0		60A			80×100×142mm	493020
GTS-75/48-D-0		75A			127×100×142mm	493021
GTS-90/48-D-0		90A			127×100×142mm	493022
GTS-120/48-D-0 VEN92		120A		■	127×100×142mm	493023

\* other nominal voltages upon request

**Semiconductor Fuse** (capsule fuse)



HL-fuse

MODEL	NOMINAL CURRENT	NOMINAL CURRENT THYRISTOR CONTROL	FUSE SIZE	PART NO
HL-fuse 5A	10A	5A	10×38mm	490971
HL-fuse 15A	25A	15A	10×38mm	490975
HL-fuse 25A	30A	25A	10×38mm	490972
HL-fuse 35A	40A	35A	41×51mm	490973
HL-fuse 50A	63A	50A	22×58mm	490974
HL-fuse 50A GTF	50A	50A	22×58mm	490986

**Fuse Holder** (capsule fuse)



Fuse holder

MODEL	RATED CURRENT (IEC)	POLES	FUSE SIZE	PART NO
Fuse holder 1-P 10x38	32A	1-Poles	10×38 mm	490976
Fuse holder 3-P 10x38	32A	3-Poles	10×38mm	490977
Fuse holder 1-P 14x51	50A	1-Poles	14×51 mm	490978
Fuse holder 3-P 14x51	50A	3-Poles	14×51 mm	490979
Fuse holder 1-P 22x58	100A	1-Poles	22×58mm	490987
Fuse holder 3-P 22x58	100A	3-Poles	22×58mm	490988



TSC Series Digital Time Switches daily-, weekly- or yearly program, DIN-rail mounting



TSC18.10EASY

MODEL	SUPPLY VOLTAGE	CHAN- NELS	NUMBER OF SWITCHING CONTACTS		SWITCHING CAPACITY	RATED CONSUMPTION	DIMENSIONS	PART NO
			CO	NO				
TSC18.10EASY*	230V AC	1		1	4000VA	1.5VA	35.8×90×60mm	711149
TSC98.20	230V AC	2	2		2500VA	2VA	71.5×120×60mm	711132
TSC98.40	230V AC	4	3	1	2500VA	2VA	71.5×120×60mm	711131

\* EASY ... programmable via smartphone (NFC)

TSC Series Digital Time Switches daily-, weekly- or yearly program, front panel mounting



TSC44.21PRO

MODEL	SUPPLY VOLTAGE	CHAN- NELS	NUMBER OF SWITCHING CONTACTS		SWITCHING CAPACITY	RATED CONSUMPTION	DIMENSIONS	PART NO
			CO	NO				
TSC44.11PRO	115V AC	1	1		4000VA	2.8VA	72×94.5×53mm	711576
TSC44.21PRO	230V AC	2	1	1	4000VA	1.5VA	72×94.5×53mm	711579

TTC Series Digital Time Switches countdown timer, front panel mounting



TTC24.21

MODEL	SUPPLY VOLTAGE	TIME RANGE	NUMBER OF SWITCHING CONTACTS	DIMENSIONS	PART NO
TTC24.21	230V AC	99 h 59 min 59 s	1 CO contact	48×48×41 mm	711450

TBG Series analog hour meters, DC voltage



TBG/TBW30

MODEL	SUPPLY VOLTAGE	COUNTING CAPACITY	ACCURACY OF READING	DIMENSIONS	PART NO
TBG30.18	12 – 48V DC	999 999 h	0.1 h	53.2×28.2×63mm	711056
TBG40.17				48×48×38mm	711025
TBG70.18		17.5×85×61.5mm		711435	
TBG70.29		35×90×60mm		711408	

TBW Series analog hour meters, AC voltage



TBG/TBW40

MODEL	SUPPLY VOLTAGE	RATED FREQUENCY	COUNTING CAPACITY	ACCURACY OF READING	DIMENSIONS	PART NO
TBW40.18	24V AC	50Hz	99 999 h	0.01 h	48×48×38 mm	711045
TBW40.18	115V AC				48×48×38 mm	711042
TBW70.18	115V AC				17.5×85×61.5 mm	711434
TBW30.18	230V AC				53.2×28.2×63 mm	711050
TBW40.18	230V AC				48×45×38 mm	711040
TBW70.18	230V AC				17.5×85×61.5 mm	711430
TBW70.29	24V AC	50/60Hz	99 999 h	0.1 h	35×90×60 mm	711355
TBW70.89	115V AC				35×105×60 mm	711140
TBW70.89	230V AC				35×105×60 mm	711141
TBW70.29	230V AC				17.5×85×61.5 mm	711350

ACCESSORIES TBG, TBW

DESCRIPTION

PART NO



TBG/TBW70.18  
TBG/TBW70.29

SB-TBX30	tension bracket for TBG/TBW30	711809
B55-TBX40	shutter for TBG/TBW40 (55×55mm)	711800
ME72-TBX40	screen for TBG/TBW40 (72×72mm)	711801
SB-TBX40	retaining clip for TBG/TBW40	711807
DR-TBW40	sealing ring for TBW40 (IP54)	711813
KA-TBX70.29	terminal cover for TBG/TBW70.29 (sealable)	711812

## SWITCHING POWER SUPPLIES – DC POWER SUPPLIES (DIN RAIL MOUNTABLE)

**Industrial Housing** for switch cabinet and plant construction

MODEL	OUTPUT VOLTAGE	OUTPUT POWER	OUTPUT CURRENT	PART NO
NDR-75-24	24V DC	75W	3,2A	491630
NDR-120-24	24V DC	120W	5,0A	491601
NDR-240-24	24V DC	240W	10A	491610
NDR-480-24	24V DC	480W	20A	491619



- ✓ Output voltage 24V DC
- ✓ Output power 75 – 480W
- ✓ Overload and short circuit protection

**Installation Housing** for building and plant engineering

MODEL	OUTPUT VOLTAGE	OUTPUT POWER	OUTPUT CURRENT	PART NO
HDR-30-12	12V DC	24W	2A	491712
HDR-15-24	24V DC	15,2W	0,63A	491701
HDR-30-24	24V DC	36W	1,5A	491702
HDR-60-24	24V DC	60W	2,5A	491703
HDR-100-24	24V DC	92W	3,83A	491704



- ✓ Output voltage 24V DC
- ✓ Output power 15 – 92W
- ✓ Overload and short circuit protection



PRODUCT SERIES	HOUSING	MEASUREMENT PARAMETER	FUNCTION	ADDITIONAL FUNCTION	OUTPUT	TERMINAL	SUPPLY VOLTAGE
E ENYA	1 17.5mm	Z Timer	M multifunction	F Remote potentiometer	delayed	Push-in terminal (VEO)	230 V AC
V VEO	2 22.5mm		Q quattro (4 funct.)		10 1 contact	Potential free contact (KAPPA)	24V DC
G GAMMA	3 35.0mm		E ON delay		20 2 contacts		24-240 V AC/DC
K KAPPA	4 45.0mm		R OFF delay		instantaneous		etc.
			I flasher		01 1 contact		
			S star-delta (wye-delta)		02 2 contacts		
			A OFF delay without auxiliary voltage		delayed and instantaneous		
			NT emergency light tester		11 1 delayed contact 1 instantaneous contact		
			TP staircase timer				
			WI impulse switch mode				
			ET ON delay 2-wire connected				



Example product code time delay relay

**E 1 Z M 20 24-240 V AC/DC E1ZM2024-240 V AC/DC**

ENYA series, in a 17.5 mm wide housing, multifunctional timer with a SPDT relay output and a supply voltage of 12-240 V AC/DC.

PRODUCT SERIES	HOUSING	MEASUREMENT PARAMETER	FUNCTION	MEASUREMENT RANGE	ADDITIONAL FUNCTION	OUTPUT	TERMINAL	SUPPLY VOLTAGE
E ENYA	1 17.5mm	U voltage 1~	U under	230V	L latch	delayed	Push-in terminal	230 V AC
V VEO	2 22.5mm	P voltage 3-Δ	O over	10A	D digital	10 1 contact		24V DC
G GAMMA	3 35.0mm	Y voltage 3-Y	W window	400V12A	T thermistor	20 2 contacts		24-240 V AC/DC
K KAPPA	4 45.0mm	I current 1~	F error	PT100	Y asymmetry	instantaneous		etc.
		J current 3~	M multi-function	etc.	S phase sequence	01 1 contact		
		F frequency	A analog output		F quick action release	02 2 contacts		
		T temperature			T test function			
		L level			K short circuit monitoring			
		B effective power			N zero voltage safe			
		C cos φ						



Example product code monitoring relays

**V 4 I M 100A L 20 P 24-240 V AC/DC V4IM100AL20P24-240 V AC/DC**

VEO series, in a 45.0 mm wide housing, multifunctional current monitoring with two contacts and a supply voltage of 24-240 V AC/DC.

**Global Headquarters**

TELE Haase Steuergeraete Ges.m.b.H.  
Vorarlberger Allee 38  
Vienna, 1230  
Austria

**UK Office**

TELE Control Ltd.  
Park House  
200 Drake Street  
Rochdale, OL16 1PJ  
United Kingdom

**US Office**

TELE Controls Inc.  
1101 Wilson Blvd  
6th Floor  
Arlington, VA 22209  
United States

**We're here to help. Please contact us directly or get in touch with your personal TELE reseller.**

---

[tele-online.com](http://tele-online.com)  
[export@tele-haase.at](mailto:export@tele-haase.at)

Your contact:

